



USER MANUAL

MODELS:

MTX3-16-M 16x16 8K Modular Matrix

MTX3-34-M 34x34 8K Modular Matrix

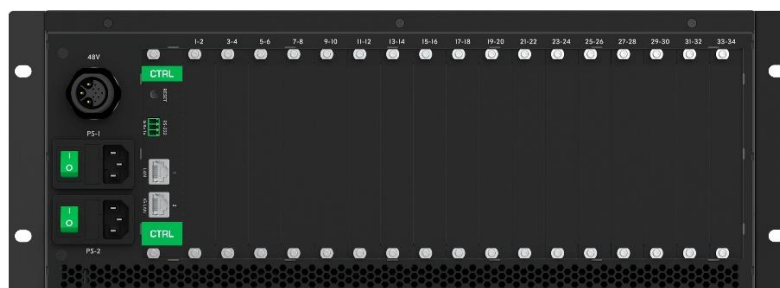
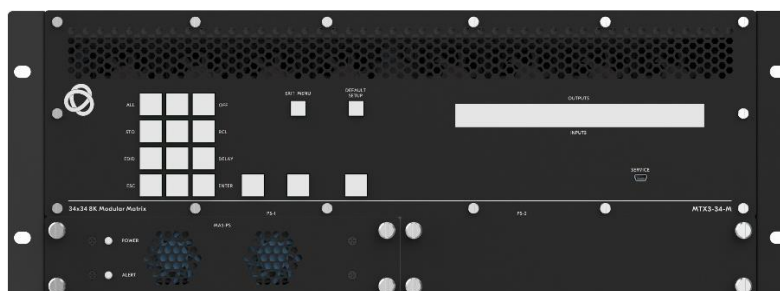

Contents

Introduction	3
Getting Started	3
Overview	4
Typical Applications	6
Defining MTX3-16-M 16x16 8K Modular Matrix	7
Defining MTX3-34-M 34x34 8K Modular Matrix	9
Mounting MTX3-16-M	12
Connecting MTX3-16-M and MTX3-34-M	13
Installing Matrix Cards	14
Identifying Input / Output Ports	15
Providing PoE to Matrix Cards	16
Managing MTX3-16-M via Ethernet	17
Managing MTX3-16-M via RS-232	19
Managing MTX3-16-M via USB (VCOM)	19
Securing MTX3-16-M Operation	20
Standard Certification	20
MTX3-16-M Security Means	20
Managing MTX3-16-M	21
Managing MTX3-16-M via Front Panel Buttons	22
Using MTX3-16-M LCD Display Menu	22
Using TAKE Button to Confirm Actions	30
Locking Front Panel Buttons	30
Managing MTX3-16-M from the Embedded Web UI	31
Opening the Embedded Web UI	32
Routing Inputs to Outputs	33
Defining User Accounts	41
Acquiring EDID	44
Configuring MTX3-16-M	45
Upgrading / Restoring Module Card Firmware	47
Configuring Input / Output Ports	48
Monitoring MTX3-16-M Hardware	50
Viewing the about Page	53
Upgrading Firmware	54
Upgrading Firmware from the Web UI	54
Upgrading Firmware – K-Upload	54
Technical Specifications	56
MTX3-16-M CNTL and Chassis	56
MTX3-34-M CNTL and Chassis	57
Matrix Cards	58
Default Communication Parameters	67
Default EDID	67
Protocol 3000	69
Understanding Protocol 3000	69
Protocol 3000 Commands	70
Result and Error Codes	83

Introduction

Welcome to Kramer Electronics! Since 1981, Kramer Electronics has been providing a world of unique, creative, and affordable solutions to the vast range of problems that confront the video, audio, presentation, and broadcasting professional on a daily basis. In recent years, we have redesigned and upgraded most of our line, making the best even better!

Getting Started

We recommend that you:

- Unpack the equipment carefully and save the original box and packaging materials for possible future shipment.
- Review the contents of this user manual.



To check for up-to-date user manuals, application programs, and if firmware upgrades are available (where appropriate):

- For MTX3-16-M, go to www.kramerav.com/downloads/MTX3-16-M.
- For MTX3-34-M, go to www.kramerav.com/downloads/MTX3-34-M.

Achieving Best Performance

- Use only good quality connection cables (we recommend Kramer high-performance, high-resolution cables) to avoid interference, deterioration in signal quality due to poor matching, and elevated noise levels (often associated with low quality cables).
- Do not secure the cables in tight bundles or roll the slack into tight coils.
- Avoid interference from neighboring electrical appliances that may adversely influence signal quality.
- Position your Kramer **MTX3-16-M** / **MTX3-34-M** away from moisture, excessive sunlight and dust.

Safety Instructions



Caution:

- This equipment is to be used only inside a building. It may only be connected to other equipment that is installed inside a building.
- For products with relay terminals and GPIO ports, please refer to the permitted rating for an external connection, located next to the terminal or in the User Manual.
- There are no operator serviceable parts inside the unit.

**Warning:**

- Use only the power cord that is supplied with the unit.
- When connecting the device to power, only use a grounded socket.
- Disconnect the power and unplug the unit from the wall before installing.
- Do not open the unit. High voltages can cause electrical shock! Servicing by qualified personnel only.
- To ensure continuous risk protection, replace fuses only according to the rating specified on the product label which is located on the bottom of the unit.
- All Kramer Laser Transceivers used in the matrices are:
 - UL and CDRH certified.
 - Emitting radiation of CDRH “Class 1” (when installed without connecting a fiber optic cable).
 - Complying with IEC 62368-1 and IEC 60825-1 and –2.

Recycling Kramer Products

The Waste Electrical and Electronic Equipment (WEEE) Directive 2002/96/EC aims to reduce the amount of WEEE sent for disposal to landfill or incineration by requiring it to be collected and recycled. To comply with the WEEE Directive, Kramer Electronics has made arrangements with the European Advanced Recycling Network (EARN) and will cover any costs of treatment, recycling and recovery of waste Kramer Electronics branded equipment on arrival at the EARN facility. For details of Kramer’s recycling arrangements in your particular country go to our recycling pages at www.kramerav.com/il/quality/environment.

Overview

MTX3-16-M and **MTX3-34-M** are intelligent and high-performance modular matrices for switching and distribution of multi-format audio-visual signals. Their chassis includes a CTRL central control card with secured LAN connectivity for remote management and control. All matrices are flexibly populated by any matrix cards from the same compatible family of multi-format matrix cards.

MTX3-16-M includes eight horizontal card slots and **MTX3-34-M** includes seventeen vertical card slots for flexible insertion of modular matrix cards, accommodating matrix cards with quad or dual ports of either input or output multi-format signals.



Most of the information included in this user manual is relevant to both **MTX3-16-M** and to **MTX3-34-M**.

Unless specified otherwise, **MTX3-16-M** is used throughout this user manual to refer to both devices.

Exceptional Quality

- High Resolution Audio-Visual Experience – **MTX3-16-M** is a professional, 8K-ready matrix for switching multi-format AV signals. The modular matrix cards support 4K60 4:4:4 multi-format AV signal distribution and the backplane router is ready for 8K audio-visual signal switching, enabling future upgrades to 8K-capable matrix cards.

- HDMI™ Signal Switching – HDCP 2.2 compliant, supporting deep color, x.v.Color™, CEC, lip sync, HDMI uncompressed audio channels, Dolby TrueHD, DTS-HD, 2K, 4K, and 3D as specified by the HDMI 2.0 standard.
- I-EDIDPro™ Kramer Intelligent EDID Processing™ – Intelligent EDID management of each input port by a processing algorithm that manages locking and pass-through and ensures plug & play operation for HDMI sources and display systems.
- Robust Signal Distribution – Kramer Equalization & re-Klocking™ technology professionally rebuilds switched digital signals, preparing them for distribution over long-distance copper and fiber optic cables.

Advanced and User-friendly Operation

- Comprehensive Matrix Control Options – Control can be remotely, using the Kramer Control application, for example, or locally.
- A user-friendly web-UI provides high-level remote service control.
- Locally, the RS-232 service port can be used for high-level Protocol 3000 APIs and there are front panel control buttons and an LCD screen which can perform switching operations, storage and recall of switching presets and configuration switching.
- Security-certified Operation – The matrix is certified for OWASP-10 (Open Web Application Security Project) standard compliance, ensuring secured web-UI user access and communication, and secured remote operation and management.
- Simple Professional Management – Compatibility with the Kramer enterprise management platform enables remote matrix operational management, including matrix automatic discovery and configuration, remote matrix switching operations, matrix and card diagnostics and firmware upgrade management.
- Cost-Effective Maintenance – Front-panel LED indicators, an LCD display and a low-noise field-replaceable fan cooling unit for easy matrix maintenance and troubleshooting. Local firmware upgrades can be performed via a USB port for convenient, lasting, field-proven deployment.
- Easy Installation – The compact 3U-only 19" (4U for **MTX3-34-M**) enclosure is suitable for rack mounting with a universal 100-240V AC power supply. PoE (Power over Ethernet) can be provided over HDBT cables to remote connected end-points, eliminating the need for local mains powering.

Flexible Connectivity

- Any input/output mix – Flexible matrix card slot support for either input or output cards service. Mix setup and deployment flexibly to match usage needs.
- Multi-format Distribution – The matrix card range supports multiple market-available audio-visual signals, such as HDMI™, VGA, and SDI, with analog and digital audio signals. Kramer Core™ technology enables long-distance signal distribution over standard HDBaseT copper cables and fiber optic infrastructure wiring.
- Independent Signal Switching – Modular matrix switching is fully non-blocking, where any matrix input signal can be distributed to any single or multiple output ports.
- Market-standard Interoperability – The matrix complies with HDBaseT standards and

interoperates with market available HDBaseT-certified end-points. For best reach and high-resolution distribution performance, use Kramer HDBaseT cables, and Kramer transmitter and receiver end-points.

Typical Applications

MTX3-16-M is ideal for the following typical applications:

- Professional large audio-visual switching systems in large-space facilities.
- Enterprise and government applications requiring flexible and secured large-scale multi-format AV distribution over long-distances.

Defining MTX3-16-M 16x16 8K Modular Matrix

This section defines MTX3-16-M.

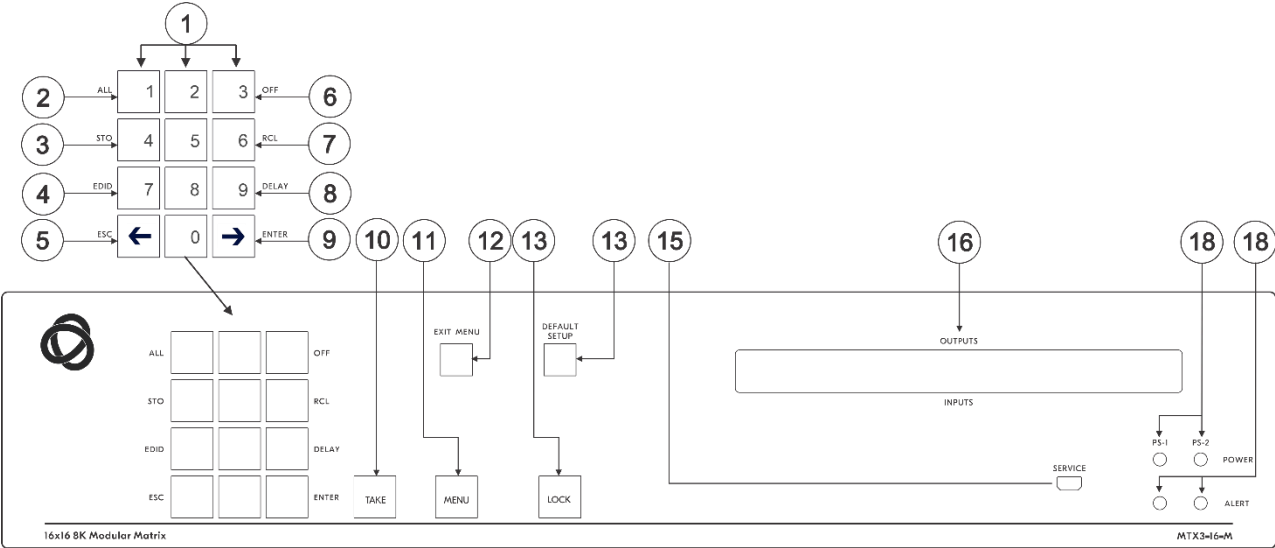

Figure 1: MTX3-16-M 16x16 8K Modular Matrix Front Panel

#	Feature	Function		
①	Numeric Keypad	Numbers	1 to 0	
		←(Move left)	Move the LCD display left (when the display is extended).	
		→(Move right)	Move the LCD display right (when the display is extended).	
②	Double-Function Selector Buttons. Enabled and lit after pressing the MENU button 4 times.	Menu Button Functions	ALL	Connect an input to all outputs.
③		STO	Store the current setup in a preset.	
④		EDID	Assign EDID channels.	
⑤		ESC	Exit the current operation.	
⑥		OFF	Turn off an output.	
⑦		RCL	Recall a preset.	
⑧		DELAY	Set the delay between confirming an action and the execution of the action on an output port.	
⑨	ENTER	Confirm the input-output setup when using a one-digit number instead of two digits. For example, to enter input 5, you can press either 05 or 5, ENTER.		
⑩	TAKE Button	Confirm action.		
⑪	MENU Button	Enable the ALL, STO, EDID, ESC, OFF, RCL, DELAY and ENTER buttons. Press again to enter the configuration menu.		
⑫	EXIT MENU Button	Press to exit a menu or return to switching mode.		
⑬	LOCK Button	Press and hold for approximately 2 sec to lock/unlock the front panel buttons. A short press returns the LCD display to the default window.		
⑭	DEFAULT SETUP Button	Press to open the reset menu on the display.		
⑮	SERVICE Mini USB Connector	Connect to a PC to send PK3000 commands to the matrix switcher.		

#	Feature	Function
①⑥	OUTPUTS/INPUTS LCD Display (OSD menu)	Displays the outputs (upper row) routed to the selected inputs (lower row). Displays user interface messages and menus.
①⑦	POWER LED (PS-1 / PS-2)	Lights green when the power supply is active.
①⑧	ERROR LED (PS-1 / PS-2)	Lights red when an error is detected. Briefly lights red immediately following a power disruption (e.g., cable disconnection, power off, and so on).

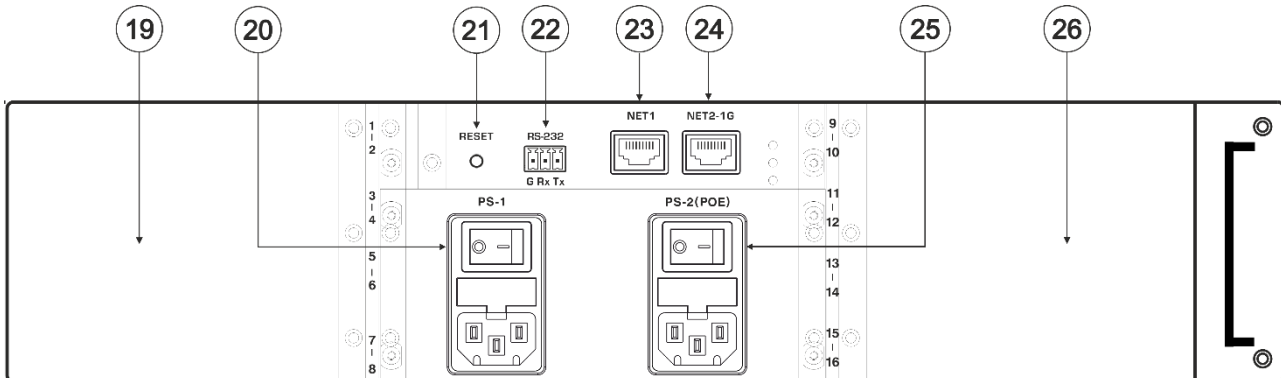

Figure 2: MTX3-16-M 16x16 8K Modular Matrix Rear Panel

#	Feature	Function
①⑨	Slots for up to 4 Matrix Cards	The left side of MTX3-16-M has 4 slots for insertion of matrix cards and the right side (26) has another 4 slots. Hot plugging: Cards can be inserted while the device is operating, and input/output ports are automatically identified and numbered. Port input/output settings can be changed and flexibly connected to other module cards' input/output ports. Matrix card ports are identified by ID numbers allocated when they are inserted (see Identifying Input / Output Ports on page 15).
②⑦	PS-1 Power Module and Switch	The PS-1 must be connected to the mains and switched on to use the device. The PS-1 power LED (17) lights green when powered. This module has a fuse holder.
②①	RESET Recessed Button	Press to reboot the MTX3-16-M control card.
②②	RS-232 3-pin Terminal Block Connector	Connect to a remote operation PC or a remote controller.
②③	NET 1 RJ-45 Connector	100Mbps Ethernet port for device management and control via LAN.
②④	NET 2-1G RJ-45 Connector	100/1000Mbps Ethernet port for matrix connection to LAN.
②⑤	PS-2 (POE) Power Module and Switch	48V PoE (Power over Ethernet) supply for inserted matrix cards. PoE is supplied when PS-2 is on and PS-1 is off, but MTX3-16-M itself will not operate. When switched on and connected to power, the PS-2 power LED ①⑧ lights green.
②⑥	Slots for up to 4 Matrix Cards	See ①⑨ for the explanation. The 4 card insertion slots on the right side of the device use port IDs 9 to 16.

Defining MTX3-34-M 34x34 8K Modular Matrix

This section defines MTX3-34-M.

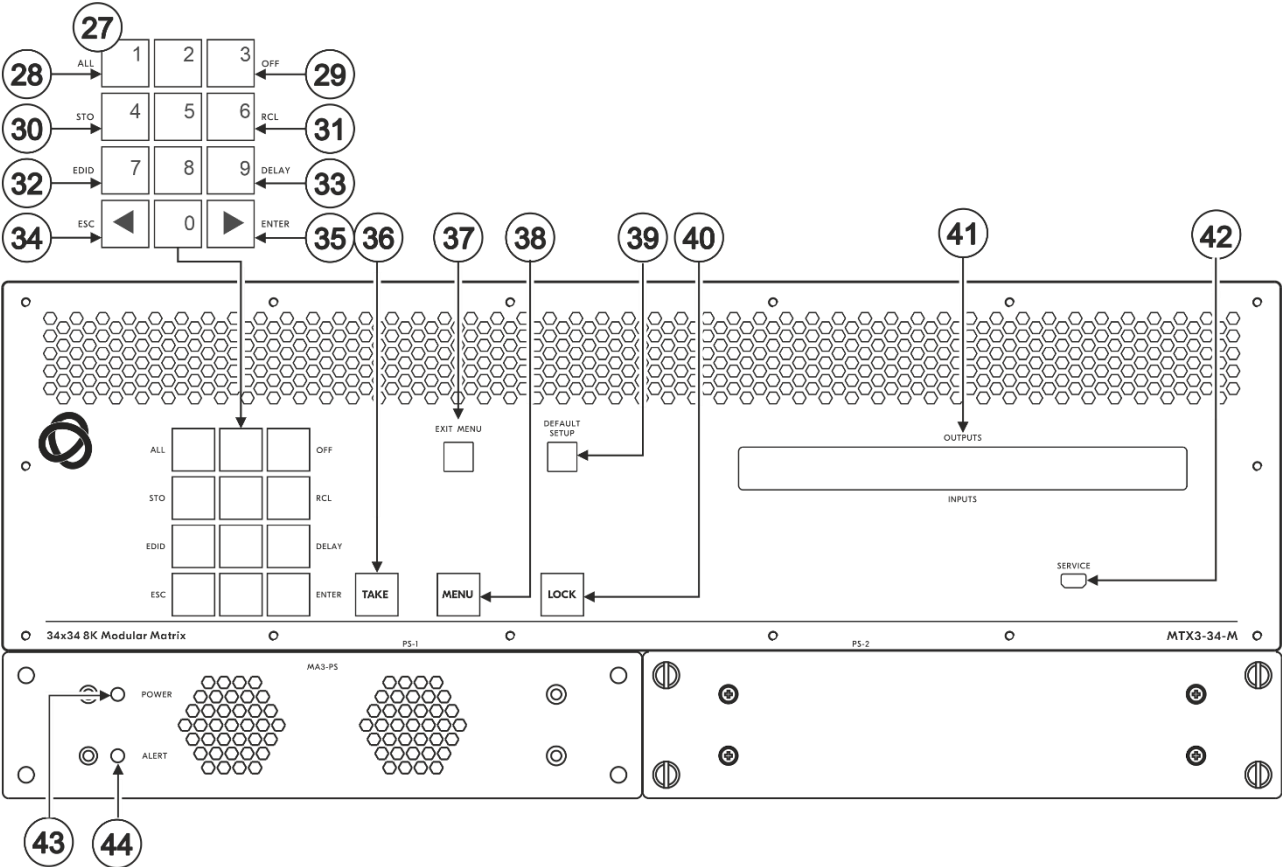

Figure 3: MTX3-34-M 34x34 8K Modular Matrix Front Panel

#	Feature	Function		
(27)	Numeric Keypad	Numbers	1 to 0	
		←(Move left)	Move the LCD display left (when the display is extended).	
		→(Move right)	Move the LCD display right (when the display is extended).	
(28)	Double-Function Selector Buttons. Enabled and lit after pressing the MENU button 4 times.	Menu Button Functions	ALL	Connect an input to all outputs.
(29)			STO	Store the current setup in a preset.
(30)			EDID	Assign EDID channels.
(31)			ESC	Exit the current operation.
(32)			OFF	Turn off an output.
(33)			RCL	Recall a preset.
(34)			DELAY	Set the delay between confirming an action and the execution of the action on an output port.
(35)	ENTER	Confirm the input-output setup when using a one-digit number instead of two digits. For example, to enter input 5, you can press either 05 or 5, ENTER.		
(36)	TAKE Button	Confirm action.		

#	Feature	Function
37	EXIT MENU Button	Press to exit a menu or return to switching mode.
38	MENU Button	Enable the ALL, STO, EDID, ESC, OFF, RCL, DELAY and ENTER buttons. Press again to enter the configuration menu.
39	DEFAULT SETUP Button	Press to open the reset menu on the display.
40	LOCK Button	Press and hold for approximately 2 sec to lock/unlock the front panel buttons. A short press returns the LCD display to the default window.
41	OUTPUTS/INPUTS LCD Display (OSD menu)	Displays the outputs (upper row) routed to the selected inputs (lower row). Displays user interface messages and menus.
42	SERVICE Mini USB Connector	Connect to a PC to send PK3000 commands to the matrix switcher.
43	POWER LED (MA3-PS)	Lights green when the power supply is active.
44	ALERT LED (MA3-PS)	Lights red when an alert status is detected. Briefly lights red immediately following a power disruption (e.g., cable disconnection, power off, and so on).

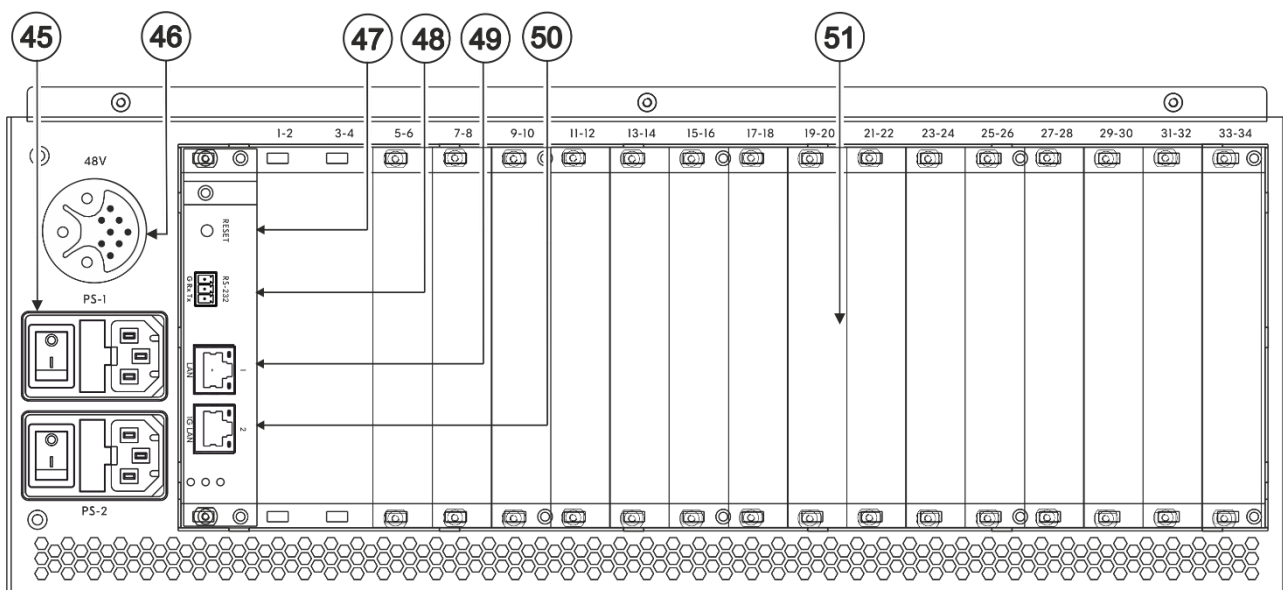

Figure 4: MTX3-16-M 16x16 8K Modular Matrix Rear Panel

#	Feature	Function
45	Power Supply and Switch (PS-1 and PS-2)	Supply power to the device and have a fuse holder. Either PS-1 or PS-2 or both must be connected to the mains and switched on to power the device. The power LED (17) lights green.



You can connect PS-1 and/or PS-2 (when installing the optional **MA3-PS** instead of the blank panel, under PS-2). If one of them fails to operate, the other can automatically power the unit.

46	48V DC Harness Connector	Connect to the MA3-PS-4812 (optional, not included) PoE power supply add-on to support PoE to the relevant matrix cards.
47	RESET Recessed Button	Press to reboot the MTX3-34-M control card.
48	RS-232 3-pin Terminal Block Connector	Connect to a remote operation PC or a remote controller.
49	NET 1 RJ-45 Connector	Connect to a PC or controller via the Ethernet LAN (100Mb).
50	NET 2-1G RJ-45 Connector	Connect to a PC or controller via the Ethernet LAN (100/1000Mb).

#	Feature	Function
51	lots for up to 17 matrix cards (15 blanks cover 15 of the slots)	<p>MTX3-34-M has 17 slots for insertion of matrix cards. MTX3-34-M uses hot plugging, so cards can be inserted while the device is operating, and the card's ports are automatically categorized as input or output. Use the system menus to change input/output designations and to create flexible connections between the ports on different cards.</p> <p>MTX3-34-M identifies ports by the ID numbers it allocates to each card slot: (see Identifying Input / Output Ports on page 15).</p>

Mounting MTX3-16-M

This section provides instructions for mounting **MTX3-16-M**. Before installing, verify that the environment is within the recommended range:



- Operation temperature – 0° to 40°C (32 to 104°F).
- Storage temperature – -40° to +70°C (-40 to +158°F).
- Humidity – 10% to 90%, RHL non-condensing.



Caution:

- Mount **MTX3-16-M** before connecting any cables or power.



Warning:

- Ensure that the environment (e.g., maximum ambient temperature & air flow) is compatible for the device.
- Avoid uneven mechanical loading.
- Appropriate consideration of equipment nameplate ratings should be used for avoiding overloading of the circuits.
- Reliable earthing of rack-mounted equipment should be maintained.

To Mount MTX3-16-M in a rack:

- Attach both rack ears (by removing the screws from each side of the machine and replacing those screws through the rack ears).



For more information go to www.kramerav.com/downloads/MTX3-16-M



Connecting MTX3-16-M and MTX3-34-M



You can insert matrix cards into slots while the device is powered.

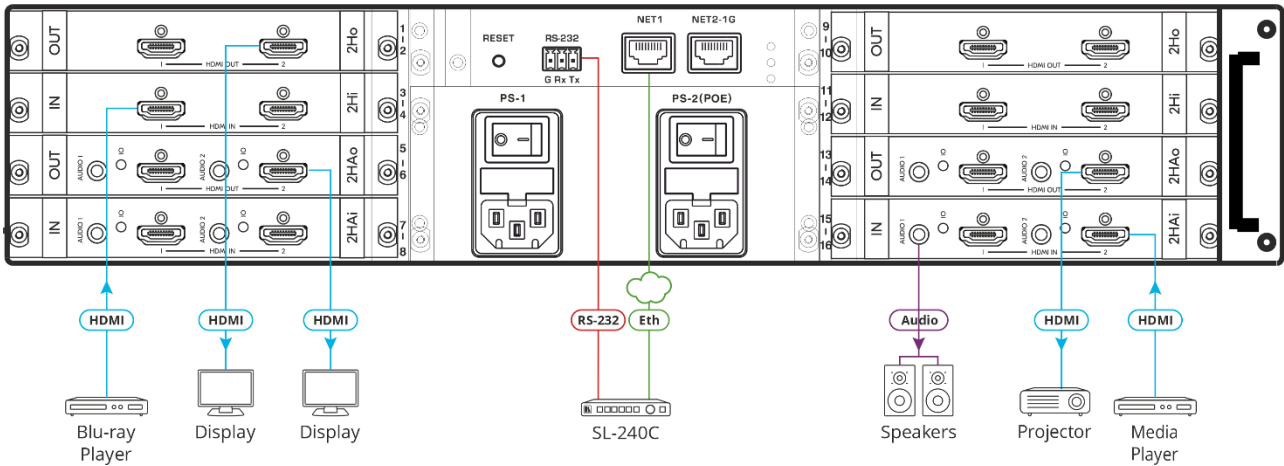

Figure 5: Connecting to the MTX3-16-M

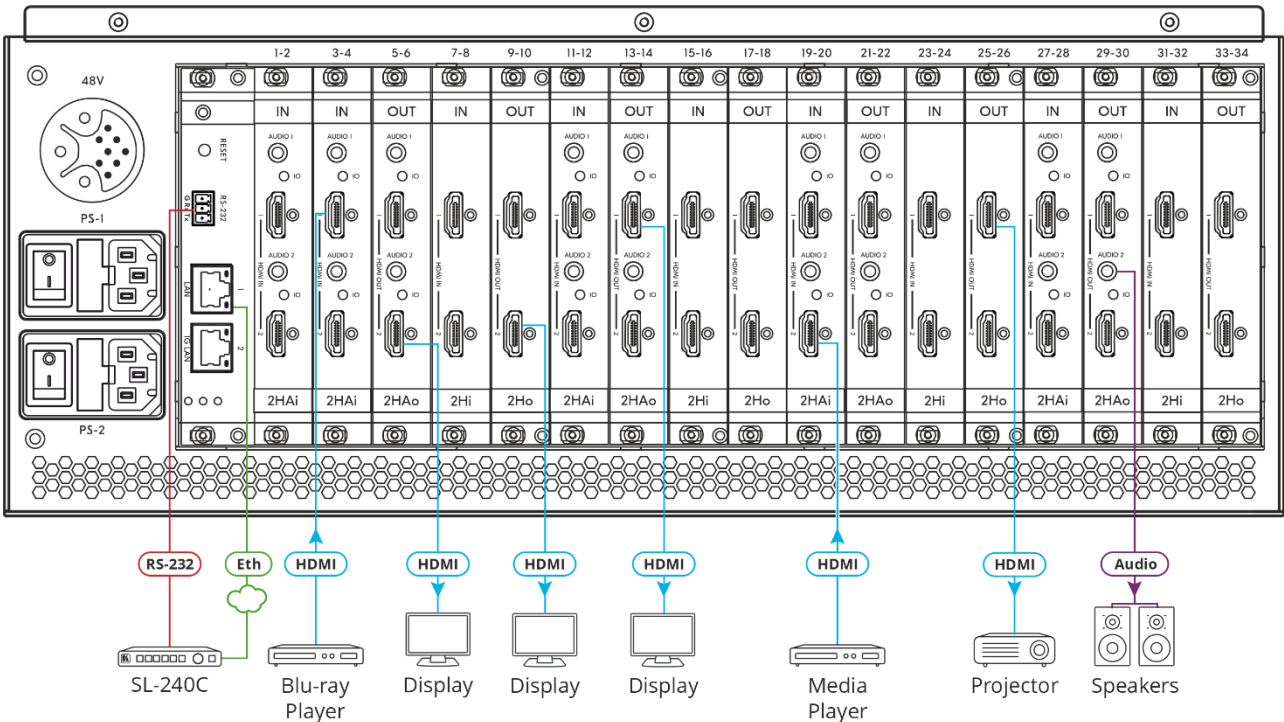

Figure 6: Connecting to the MTX3-34-M



For optimum range and performance use the recommended Kramer cables available at www.kramerav.com/downloads/MTX3-16-M. Using third-party cables may cause damage!



The matrix card slot configuration shown above is for demonstration purposes. Different input / output matrix card types may be mixed as required.

To connect MTX3-16-M as illustrated in the example in [Figure 5](#):

1. Install the matrix cards into the slots.
For matrix card insertion instructions see [Installing Matrix Cards](#) on page [14](#).
2. Connect the matrix card's ports to the HDMI sources / acceptors and audio components.
3. Connect the RS-232 port to a controller.
See [Managing MTX3-16-M via RS-232](#) on page [19](#).
4. Connect the NET1 port to the Kramer **SL-240C** controller via LAN.
See [Managing MTX3-16-M via Ethernet](#) on page [17](#).
5. Connect PS/1 to the mains electricity and switch it on.
6. Review and configure the system, using:
 - The front panel menu, see [Managing MTX3-16-M](#) on page [21](#).
 - The embedded web UI menus, see [Managing MTX3-16-M from the Embedded Web UI](#) on page [31](#).

Installing Matrix Cards

Modular Matrix cards are installed horizontally for **MTX3-16-M** and vertically for **MTX3-34-M**, in the same way.

Insert matrix cards into any of the slots on the rear of the **MTX3-16-M** chassis. For an explanation of how the system identifies each port, see [Identifying Input / Output Ports](#) on page [15](#).



You can insert cards into slots while the device is powered.



The insertion process is the same for all cards.

To install an input / output card:

1. Use a Phillips screwdriver to loosen the screws:
 - For **MTX3-16-M** left and right of the blank plate.
 - For **MTX3-34-M** top and bottom of the blank plate.
2. Remove the blank plate from the slot and store it for possible future use.
3. Remove the new card from its shipping box and anti-ESD bag.
4. Holding the card by the protruding handle, align the card with the plastic guide rails.
5. Slide the card into the chassis until the front of the card contacts the connector inside the chassis.
6. Press the card firmly into the slot until the connector plate is flush with the rear panel of the chassis and the connector is fully seated.
7. Tighten the retaining screws at the sides of the card to secure it to the chassis.

- 8. Power on the new card and configure it using the front panel menu or the embedded web-UI menu.



Figure 7: Input / Output Card Installation on the MTX3-16-M

Identifying Input / Output Ports

Matrix cards that are installed into the card slots on the **MTX3-16-M**, include input and/or output ports. Each card slot has 2 port ID numbers to be assigned to the inserted card. In total there are 16 port IDs available (34 for **MTX3-34-M**).

Two types of Matrix cards are available, with different identification methods:

- 2-port cards (see [Identifying Port ID for 2-Port Cards](#) on page 15).
- 4-port cards (see [Identifying Port ID for 4-Port Cards](#) on page 16).

Port input/output directions are defined per port ID number.

 2-port matrix cards have 2 of either input or output ports where each port has its unique ID number.

Identifying Port ID for 2-Port Cards

The port ID numbers are written on the chassis, next to each card-insertion point.

- For **MTX3-16-M**, ports on the left side of the card use one port ID number and ports on the right side of the card use the next port ID number.
- For **MTX3-34-M**, ports on the top side of the card use one port ID number and ports on the bottom side of the card use the next port ID number.

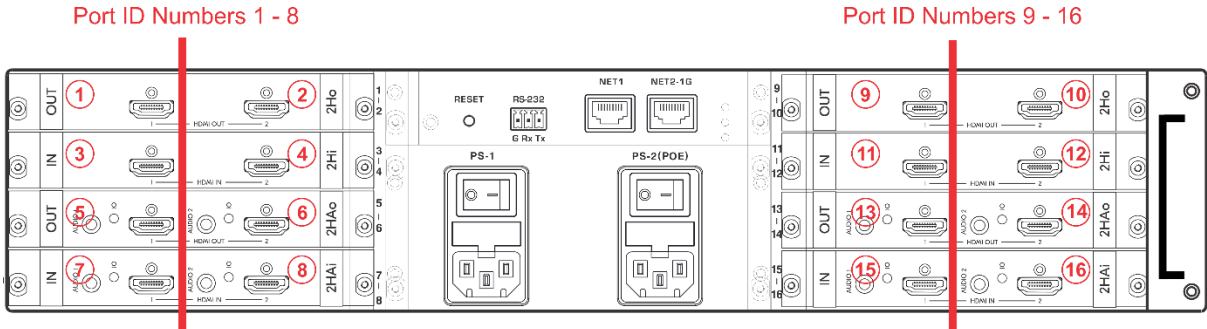

Figure 8: 2-Port Port ID Sample

Identifying Port ID for 4-Port Cards

A single 4-port matrix card can have 2 pairs of input and output ports where each pair has its unique ID number.

The port ID numbers are written on the chassis, next to each card-insertion point.

- For **MTX3-16-M**, the first ID number of the card indicates (from the left side) the first (input) and third (output), the second ID number of the card indicates the second (input) and fourth (output) ports ID number.
- For **MTX3-34-M**, the first ID number of the card indicates (from the top) the first (input) and third (output), the second ID number of the card indicates the second (input) and fourth (output) ports ID number.

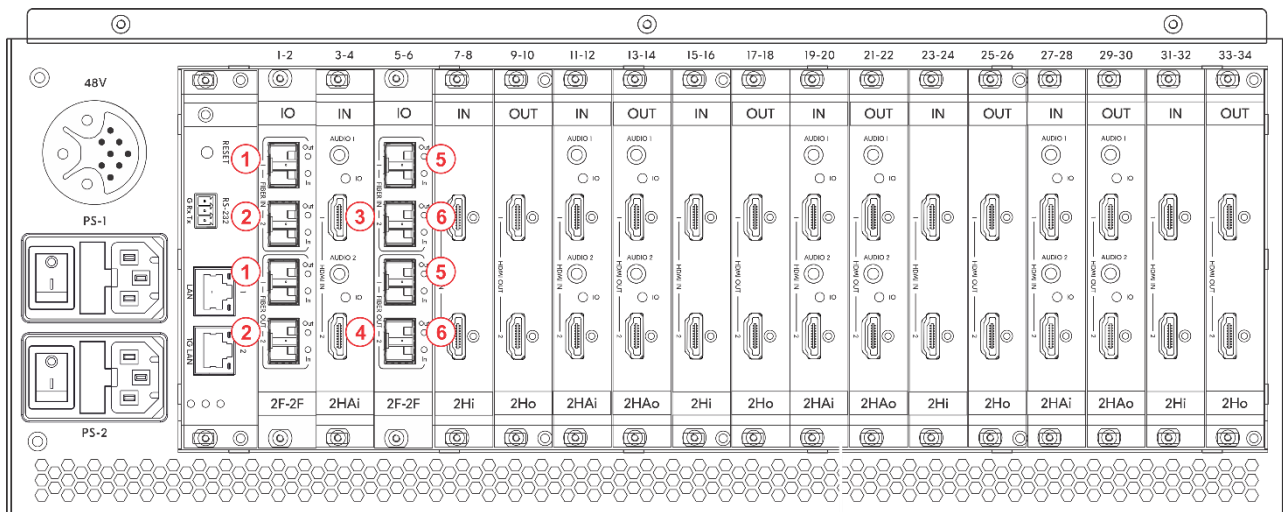

Figure 9: 4-Port Port ID Sample

Providing PoE to Matrix Cards

The Modular Matrices provide PoE to cards (for example to **DTAxr-IN2-F34**) as follows:

- [Providing PoE for MTX3-16-M](#) on page [16](#).
- [Providing PoE for MTX3-34-M](#) on page [17](#).

Providing PoE for MTX3-16-M

When the **MTX3-16-M** PS-2 (PoE) power module (25) is switched on and connected to the mains, the matrix can supply 48V PoE to matrix cards with an HDBaseT connection to its PoE-compatible connected endpoint.

PoE is supplied, even if PS-2 is on and PS-1 (20) is off (the **MTX3-16-M** itself does not operate without PS-1). When PoE is provided, the PS2 power LED (17) lights green.

Providing PoE for MTX3-34-M

When the **MA3-PS-4812** (optional, not included) PoE power supply add-on is connected to the **MTX3-34-M** 48V socket (46), the matrix can supply 48V PoE to matrix cards with an HDBaseT connection, to its PoE-compatible connected end-point.

Managing MTX3-16-M via Ethernet

To manage **MTX3-16-M** via Ethernet, connect to it using one of the following methods:

- [Connecting to a LAN Switch](#) on page [17](#).
- [Connecting Directly to a PC with a Crossover Cable](#) on page [17](#).



If you need to connect to LAN with IPv6 addressing, ask your IT department for installation instructions.

Connecting to a LAN Switch

Connect the **MTX3-16-M** NET-1 (23) Ethernet port (on the CNTL card) to a LAN switch port.

Typically, LAN DHCP server automatically allocates an IP address to the matrix. To view the matrix IP address on the front panel, press the **MENU** button (11), five times and press 1 to view the ETH0 IP (Ethernet port NET-1 (23)) address.

Connecting Directly to a PC with a Crossover Cable

Manage **MTX3-16-M** by connecting a crossover cable from the device to the Ethernet port on your PC.



This type of connection is recommended for identifying the **MTX3-16-M** IP address during normal operation or following factory reset.

To configure your PC after connecting **MTX3-16-M** to the Ethernet port:

1. Click **Start > Settings > Network & Internet**.
2. In the **Advanced network settings**, click **Change adapter options**.
3. Highlight the network adapter you want to use to connect to the device and click **Change settings of this connection**.

The Local Area Connection Properties window for the selected network adapter appears as shown below:

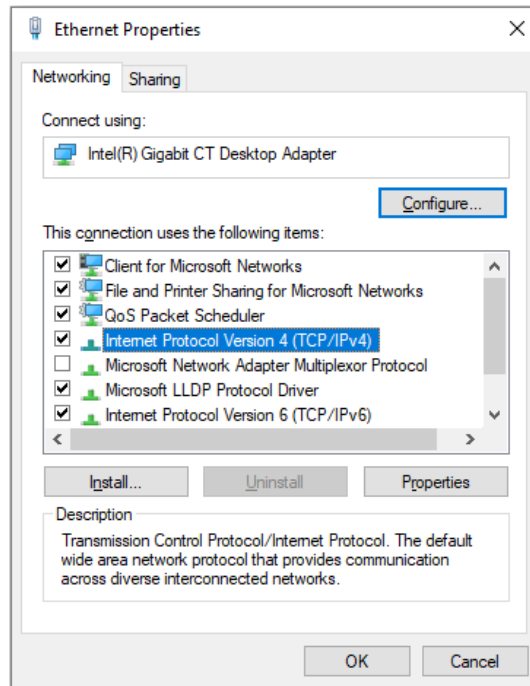

Figure 10: Local Area Connection Properties Window

4. Highlight **Internet Protocol Version 4 (TCP/IPv4)**.
5. Click **Properties**.
The Internet Protocol Properties window relevant to your IT system appears.

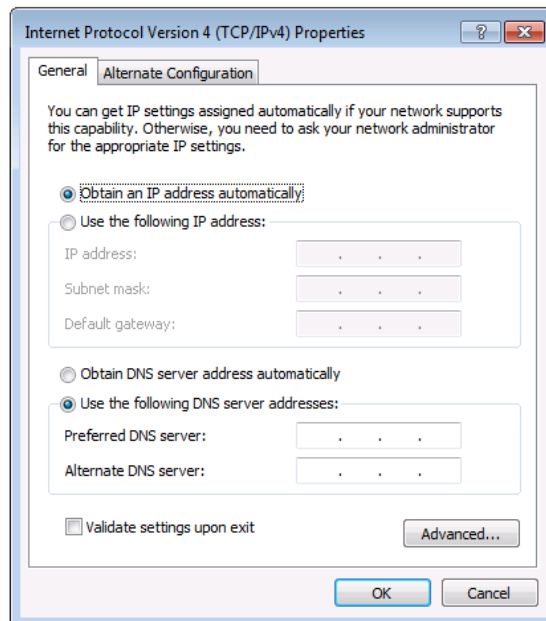

Figure 11: Internet Protocol Version 4 Properties Window

- Select **Use the following IP Address** for static IP addressing and fill in the details as shown below. You can use any IP address in the range 192.168.1.1 to 192.168.1.255 (excluding 192.168.1.39) that is provided by your IT department.

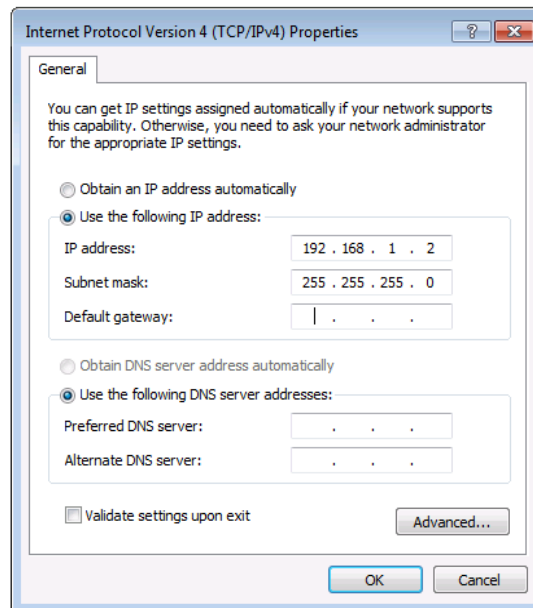

Figure 12: Internet Protocol Properties Window

- Click **OK**.
- Click **Close**.

Managing MTX3-16-M via RS-232

Control MTX3-16-M via an RS-232 connection (22) using, for example, a controller.

MTX3-16-M features an RS-232 3-pin terminal block connector allowing the RS-232 to control MTX3-16-M.

Connect the RS-232 terminal block on the rear panel of MTX3-16-M to a PC/controller. From the RS-232 9-pin D-sub serial port, connect:

- Pin 2 to the TX pin on the MTX3-16-M RS-232 terminal block
- Pin 3 to the RX pin on the MTX3-16-M RS-232 terminal block
- Pin 5 to the G pin on the MTX3-16-M RS-232 terminal block

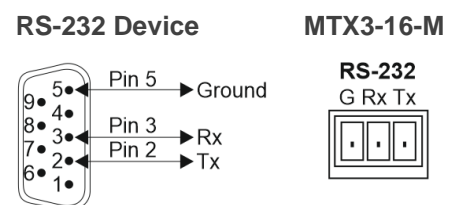

Managing MTX3-16-M via USB (VCOM)

The device's SERVICE Mini USB Connector (15) can work as a virtual COM (VCOM) port. Verify that the USB port on the PC that connects to MTX3-16-M is configured as a VCOM port. You may need to install a driver to do this. You can use a tool such as Hercules to use Protocol 3000 commands over USB (see [Protocol 3000](#) on page 69). You can also use K-Upload to upgrade firmware over USB (see [Upgrading Firmware – K-Upload](#) on page 54).

Securing MTX3-16-M Operation

This section describes the MTX3-16-M Security features.

Standard Certification

MTX3-16-M has been tested and certified in compliance with security control requirements of the OWASP Application Security Verification Standard (ASVS) Project. Go to www.kramerav.com/downloads/MTX3-16-M to view OWASP certification.

MTX3-16-M Security Means

MTX3-16-M is protected by:

- [Password Protection](#) on page [20](#).
- [User Account Protection](#) on page [20](#).
- [HTTPS Protection](#) on page [20](#).

Password Protection

When accessing the web UI for the first time, the user is required to set a new password that conforms to a level of complexity. The passwords must conform to the following level of complexity (see also [Defining User Accounts](#) on page [41](#)):

- Length of 8 to 12 characters, upper and lowercase are permitted.
- The password must contain a letter, number and special character (@, \$, !, %, *, ?, &).
- Only the administrator account can change passwords.



Default passwords can only be restored following factory reset API command (see [Default Communication Parameters](#) on page [67](#)).

User Account Protection

There are 3 levels of user accounts (Administrator, Manager and Operator), enabling administrators to securely manage user access to the matrix according to their roles and privileges (see also [Defining User Accounts](#) on page [41](#)).



The Account password can only be restored following factory reset API command (see [Default Communication Parameters](#) on page [67](#)), not from the front panel or from the embedded web UI.

HTTPS Protection

By default, all IP-based matrix management and control uses HTTPS, including the embedded web UI and protocol 3000 API.

Managing MTX3-16-M

Manage, operate and control **MTX3-16-M**:

- From the LCD menu (using the front panel buttons), see (see [Managing MTX3-16-M via Front Panel Buttons](#) on page [22](#)).
- Using the embedded web UI menu, see [Managing MTX3-16-M from the Embedded Web UI](#) on page [31](#).
- Using Protocol 3000 commands, see [Protocol 3000](#) on page [69](#).

 The account default password can only be restored following factory reset API command, (see [Default Communication Parameters](#) on page [67](#)), not from the front panel or from the embedded web UI.

Managing MTX3-16-M via Front Panel Buttons

Press **MENU** (11), to go through the menu that appears on the LCD screen screens.



After 6 seconds of inactivity, the screen reverts to the main menu (current switching status).

Press the ◀ (backward) or ▶ (forward) buttons (1) to shift right or left within the LCD displayed text.



At any point, press the **LOCK** (13) or **EXIT** (12) to exit and return to the normal operation display.

The **MTX3-16-M** front panel enables performing the following actions:

- [Using MTX3-16-M LCD Display Menu](#) on page [22](#).
- [Using TAKE Button to Confirm Actions](#) on page [30](#).
- [Locking Front Panel Buttons](#) on page [30](#).

Using MTX3-16-M LCD Display Menu

When powering the device, the LCD display runs through various screens and then remains in the normal operation display, showing the current switching status.



The screens described in this section are the same for **MTX3-34-M** except for the number of ports (34 instead of 16).

To start up MTX3-16-M:

1. Turn on the power switch.

The LCD display shows a series of screens as **MTX3-16-M** is booting up:

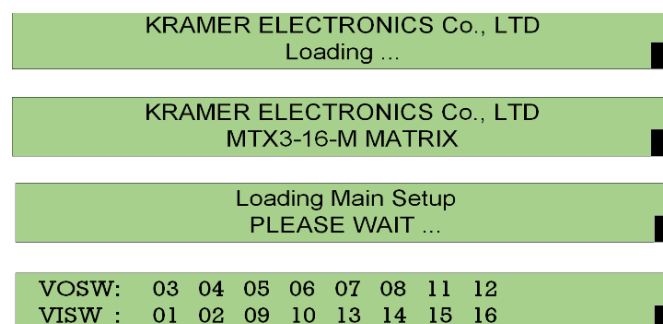

Figure 13: LCD Display Bootup Screens (shown in sequence)

The last screen in the sequence is the normal operation mode.

2. Press the **Menu** button to scroll through the menu options.

The menu is ready to use.

The LCD display menu enables performing the following actions:

- [Viewing Ports ID](#) on page [23](#).
- [Switching Input Signals to Outputs](#) on page [24](#).
- [Storing and Recalling Presets](#) on page [27](#).
- [Delaying a Switching Action](#) on page [28](#).
- [Copying EDIDs](#) on page [28](#).
- [Viewing Network Settings](#) on page [29](#).
- [Restarting and Resetting the Matrix Via LCD Menu](#) on page [29](#).
- [Viewing MTX3-16-M Firmware Versions](#) on page [30](#).

Viewing Ports ID

View the available video and audio port IDs (on the inserted cards) via the LCD display menu.



Go to [Identifying Input / Output Ports](#) on page [15](#) to understand how to identify port IDs.

To view video ports ID:

1. Pres **MENU** 1 time. The Ports ID window.
2. View the video input and output IDs.

```
VOUT: 03 04 05 06 07 08 13 14
VIN : 01 02 09 10 11 12 15 16
```

VOUT (video out) – Available video output port IDs (on the inserted cards) list.

VIN (video in) – Connected (to above output port ID) video input port IDs.

To view audio ports ID:

1. Pres **MENU** 1 time. The Ports ID window.
2. View the video input and output IDs.

```
AOUT: 03 04 05 06 07 08 13 14
AIN : 01 02 09 10 11 12 15 16
```

AOSW (audio output switch) – Available audio output port IDs list.

AISW (audio input switch) – Connected (to above output port ID) audio input port IDs.

Switching Input Signals to Outputs

MTX3-16-M enables switching inputs to outputs via the LCD display **(16)** menu, using the Numeric Keypad **(1)**.

When using the Numeric Keypad:

- To enter a single digit number (for example 5), either press 0 followed by 5, or 5 followed by the ENTER Button **(9)**.
- Press 00 (or 0 followed by the ENTER button) to disconnect the currently entered output number from the routed input.
- Use the ESC Button **(5)** to cancel an operation without affecting the current status. For example, if you enter an incorrect number by mistake, press **ESC** to cancel the operation.



At any stage, if no button is pressed within approximately 15 seconds, the automatic timeout causes **MTX3-16-M** to exit the operation and revert to the output/input display.

MTX3-16-M enables performing the following switching actions:

- [Switching a Video Input Signal to an Output](#) on page [24](#).
- [Switching an Audio Input Signal to an Output](#) on page [25](#).
- [Switching Multiple Inputs to Multiple Outputs](#) on page [25](#).
- [Switching an Input to all Outputs](#) on page [26](#).
- [Turning Outputs Off](#) on page [27](#).

Switching a Video Input Signal to an Output

Use the **MTX3-16-M** front panel LCD display to switch a video input signal to an output. In normal operation mode (switching mode), the switching state is displayed:

```
VOSW: 03 04 05 06 07 08 11 12
VISW : 01 02 09 10 13 14 15 16
```

VOSW (Video Output SWitch) – Shows video output port IDs.

VISW (Video Input SWitch) – Shows the video input ports that are switched to the video output ports (shown above).

To switch a video input signal to a selected output using the front panel buttons:

1. On the Numeric Keypad, press the number of the desired video output (for example, 01).

The in/out routing appears on the right side of the LCD display with the input blank.

```
VOSW: 01 02 03 04 05 06 07 08
VISW: 11 12 13 14 15 16 09 IN__=>OUT01
```

Figure 14: Video Switching – Blank Input

2. Press the number of the desired video input (for example, 16).

The input is displayed, and the video is switched to the new output destination immediately.

```
VOSW: 01 02 03 04 05 06 07 08
VISW: 11 12 13 14 15 16 09 IN16=>OUT01
```

Figure 15: Video Switching – Input Entered

The selected video input signal is switched to the selected output.

Switching an Audio Input Signal to an Output

Use the **MTX3-16-M** front panel LCD display to switch an audio input signal to an output.

In the audio switching state:

```
AOSW: 03 04 05 06 07 08 13 14
AISW :
```

AOSW (Audio Output SWitch) – Shows the audio output ports.

AISW (Audio Input SWitch) – Shows the audio input ports that are switched to the video output ports (shown above).

To switch an input audio signal to a selected output using the front panel buttons:

1. Press the **MENU** button (11) twice.

The current audio switching setup is displayed on the LCD display.

```
AOSW: 01 02 03 04 05 06 07 08
AISW: 13 13 13 13 13 09 09
```

Figure 16: Audio Switching – Blank Input

2. On the Numeric Keypad (1), press the number of the desired output.

The in/out routing appears on the right side of the LCD display with the input blank.

```
AOSW: 01 02 03 04 05 06 07 08
AISW: 13 13 13 13 13 09 09 IN__=>OUT01
```

Figure 17: Audio Switching – Output Entered

3. Press the number of the desired input.

The input is displayed, and the audio is switched immediately.

```
AOSW: 01 02 03 04 05 06 07 08
AISW: 11 12 13 14 15 16 09 IN09=>OUT01
```

Figure 18: Audio Input Entered

The selected audio input is switched to a selected output.

Switching Multiple Inputs to Multiple Outputs

Use the **MTX3-16-M** front panel LCD display together with the TAKE button to route more than one input to an output at the same time.



This section describes multiple video switching, but the same applies to multiple audio switching.

To switch multiple inputs and outputs:

1. Press **TAKE** on the front panel. The button turns red.
2. On the Numeric Keypad, press the number of the desired video output (for example, 01).

The in/out routing appears on the right side of the LCD display with the input blank.

```
VOSW: 01 02 03 04 05 06 07 08
VISW: 11 12 13 14 15 16 09 IN__=>OUT01
```

Figure 19: LCD Video Switching Screen

3. Press the number of the desired video input (for example, 16).

The input is displayed, and the video is switched to the new output destination immediately.

VOSW:	01	02	03	04	05	06	07	08	
VISW:		11	12	13	14	15	16	09	IN16=>OUT01

Figure 20: Video Input Entered

TAKE button flashes.

4. Enter the next output port. TAKE button lights.
5. Enter the input to route to the second output. TAKE button flashes red.
6. Add additional IN-OUT pairs as required.
7. Press **ESC** to view all the IN-OUT pairs to switch.
8. Press **TAKE**.

Multiple IN-OUT pairs are switched.

Switching an Input to all Outputs

Use the **MTX3-16-M** front panel to switch an input to all outputs at once.

To switch an input to all outputs:

1. Press the **MENU** button (11), four times. The Functions screen appears on the LCD display.

1: inXX=>ALL	3:outXX=OFF	7:EDID	9:Delay
4: store setup XX	6: recall setup XX		

Figure 21: Functions Screen – ALL Function

2. Press Numeric key **ALL** (2) (also “1”) on the front panel. The inXX=>ALL screen appears on the LCD display.
3. Select the input signal type to switch to all the inputs:
 - **Video input:** Press **ALL** (1) on the numeric keypad to switch the video signal.
 - **Audio input:** Press 1 on the numeric keypad to switch the video signal.
4. Enter the desired input number. TAKE button flashes.
5. Press **TAKE**.

All outputs are switched to the selected input.

Turning Outputs Off

Use the **MTX3-16-M** front panel to turn outputs off - This means that no input is switched to the output. The front panel display will show a blank input beneath the output.

To turn an output off:

1. Press the **MENU** button (11), four times. The Functions screen appears on the LCD display.

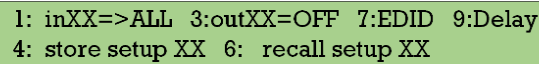

```

1: inXX=>ALL  3:outXX=OFF  7:EDID  9:Delay
4: store setup XX  6: recall setup XX
  
```

Figure 22: Functions Screen – ALL Function

2. Press **OFF** (6) (also “3”) on the numeric keypad.
The following message is displayed:

```
out__ => OFF
```

3. Enter the relevant output number (for example, 01). **TAKE** button flashes.

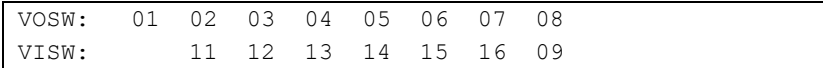

```

VOSW:  01  02  03  04  05  06  07  08
VISW:      11  12  13  14  15  16  09
  
```

Figure 23: Out 01 Off

4. Press **TAKE**.

The selected output is switched off.

Storing and Recalling Presets

Use the **MTX3-16-M** front panel to store (save) and recall up to 60 different input/output connection scenarios.

To store the current input/output connection scenarios as a preset:

1. Press **MENU** (11), four times.

The Functions screen appears on the LCD display.

2. Press **STO** (3) and enter the preset number (1 to 60) under which you would like to save the connection scenario. **TAKE** button flashes.



If this preset is not empty a warning message appears.

3. Press **TAKE**.

The current input/output configuration is stored.

To recall a stored preset:

1. Press the **MENU** button (11), four times.

The Functions screen appears on the LCD display.

2. Press **RCL** (7) and enter the preset number (1 to 60) you would like to recall. The **TAKE** button flashes.
3. Press **TAKE** (10) to confirm.

The preset is recalled and the input/output configuration changes to the selected preset.

Delaying a Switching Action

Use the **MTX3-16-M** to set a delay time (0 to 15) for a switching action.



Each delay unit equals 200ms.

For example, setting delay time to 15, delays the switching action by 3 seconds. (15 x 200ms = 3 seconds).

To set the output time delay:

1. Press the **MENU** (11) 4 times.
2. The Functions screen appears on the LCD display.
3. Press **DELAY** (8).
4. Using the numeric keys, enter the output number and number of delay units.
for example, OUT3 delay is set to delay time 9 (1.8 seconds). The TAKE button flashes.

```

OLIST: 03 04 05 06 07 08 11 12
DTIME: 09 0 0 0 0 0 0 0
  
```

Figure 24: 1.8 second delay on output 1

5. Press **TAKE** (10) to confirm your selection.

The execution delay for the selected output is set.

Copying EDIDs

Use the **MTX3-16-M** front panel LCD display to copy an EDID from any input or output to any input.

To copy an EDID:

1. Press the **MENU** button (11), four times.
The functions screen appears on the LCD display.
2. Press **EDID** (4) (also "7").
The EDID Copy screen appears.
3. Enter the SOURCE number (you can select either an input or an output port number) and the DEST number (select an input port).
4. Wait for Success message on the LCD display.

The EDID is copied.

Viewing Network Settings

Use the **MTX3-16-M** front panel LCD display to view the device IP Address and other network settings.

To view network settings:

1. Press **MENU** (11), on the numeric keypad 5 times. The Ethernet Display screen appears on the LCD display.
2. View the IP Address:
 - Press **1** on the numeric keypad to view ETH0 IP (port NET-1 (23) on the chassis) address.
 - Press **2** on the numeric keypad to view ETH1 IP (port NET2-1G (24) on the chassis) address.

Network settings are viewed.

Restarting and Resetting the Matrix Via LCD Menu

Use the **MTX3-16-M** front panel LCD display to reboot the device or reset it to its default parameters.



Factory Reset via the front panel does not reset administrator/user accounts and passwords or the MAC address and device serial number. Use the embedded web UI or Protocol 3000 commands to restore default factory-set passwords.

To reset or restart the device:

1. Press **MENU** (11), on the numeric keypad 6 times. The Matrix Reset screen appears on the LCD display.

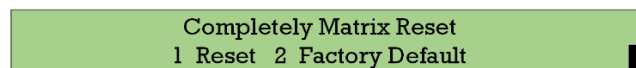

Figure 25: Matrix Reset LCD Display

2. do any of the following:
 - Press **1** on the numeric keypad to restart the device.
 - Press **2** on the numeric keypad to reset the device to Its factory default settings.

The TAKE button flashes twice.

3. Press **TAKE** twice as instructed on the LCD display.

Device has restarted/reset.

Viewing MTX3-16-M Firmware Versions

Use the **MTX3-16-M** front panel LCD display to view the device firmware versions.

The version format is xx.yy.zzzz, where xx is the major version, yy is the revision and zzzz is build version.

To view firmware versions:

1. Press **MENU** (11), on the numeric keypad 7 times. The Version Information Display screen appears on the LCD display.

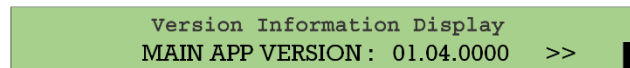

Figure 26: FW Version Display

2. Press **ENTER** or **ESC** on the numeric pad to view each of the firmware versions:
 - MAIN_APP: view firmware version.
 - SOFT_KET: view keyboard version.
 - HARD_KEY: view hardware version.

Firmware revisions are viewed.

Using TAKE Button to Confirm Actions

When using the LCD Display menu on the **MTX3-16-M**, some of the actions require confirmation. For example, when switching multiple IN/OUT pairs or when resetting the device to its default parameters.



Failure to press **TAKE** within a few seconds results in the action timing out.

Locking Front Panel Buttons

Lock the **MTX3-16-M** front panel to prevent tampering with the unit or accidental settings changes. Remote operation of the **MTX3-16-M** is unaffected (via the web pages or Protocol 3000 API commands).

To lock the front panel buttons:

- Press and hold **LOCK** (13) until the button lights up.
The front panel buttons are locked.

To unlock the front panel buttons:

- Press and hold **LOCK** (13) until the button is no longer lit.
The front panel buttons are unlocked.

Managing MTX3-16-M from the Embedded Web UI

Use the built-in, user-friendly web UI to manage and control **MTX3-16-M** over the LAN.



You can also operate and control **MTX3-16-M** using:

- Protocol 3000 commands, see [Protocol 3000 Commands](#) on page [70](#).
- Front panel buttons, see [Managing MTX3-16-M](#) on page [21](#).



MTX3-34-M and **MTX3-16-M** web UI is identical except for the number of inputs and outputs (34x34 and 16x16, respectively).



Use the **MTX3-16-M** embedded web UI for the following:

- [Opening the Embedded Web UI](#) on page [32](#).
- [Routing Inputs to Outputs](#) on page [33](#).
- [Defining User Accounts](#) on page [41](#).
- [Acquiring EDID](#) on page [44](#).
- [Configuring MTX3-16-M](#) on page [45](#).
- [Upgrading / Restoring Module Card Firmware](#) on page [47](#).
- [Configuring Input / Output Ports](#) on page [48](#).
- [Monitoring MTX3-16-M Hardware](#) on page [50](#).
- [Viewing the about Page](#) on page [53](#).

Opening the Embedded Web UI

 If an embedded web page does not update correctly, clear your Web browser's cache.

To browse the MTX3-34-M embedded web UI:

1. Type the IP address of **MTX3-16-M** in the address bar of your internet browser.
 - You can view the IP address by pressing **MENU** , five times and pressing 1 to view the ETH0 IP address (port NET-1  on the chassis).
 - If no DHCP server is used, then the default IP address is 192.168.1.39. If that is in use, you can use any IP address in the range 192.168.1.1 to 192.168.1.255.

 Because the device uses a private CA (authorization certificate), the browser displays a warning: "**Your connection isn't private**" (in Microsoft Edge – other browsers may display a different message).

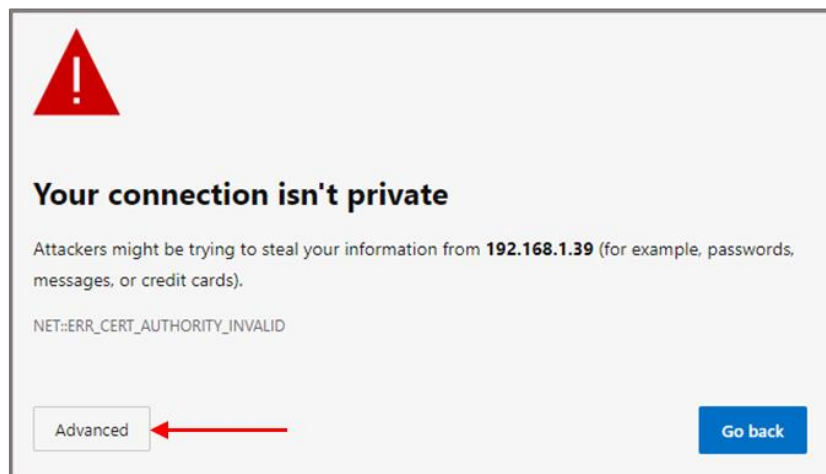

Figure 27: Microsoft Edge message

2. Click **Advanced** to continue, the Login window appears:

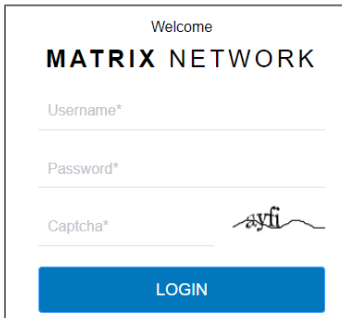



Figure 28: Embedded Web UI Login Window

-  The first login must be with the administrator default username and password (see [Default Communication Parameters](#) on page 67).
- For password requirements, (see [Securing MTX3-16-M Operation](#) on page 20).
- To define new users after logging in, see [Creating or Deleting User Accounts](#) on page 43.

 After the first login, you need to change the admin password and re-login.

- 3. If the captcha is unclear, click its image to load a new one.
- 4. The main landing page appears.

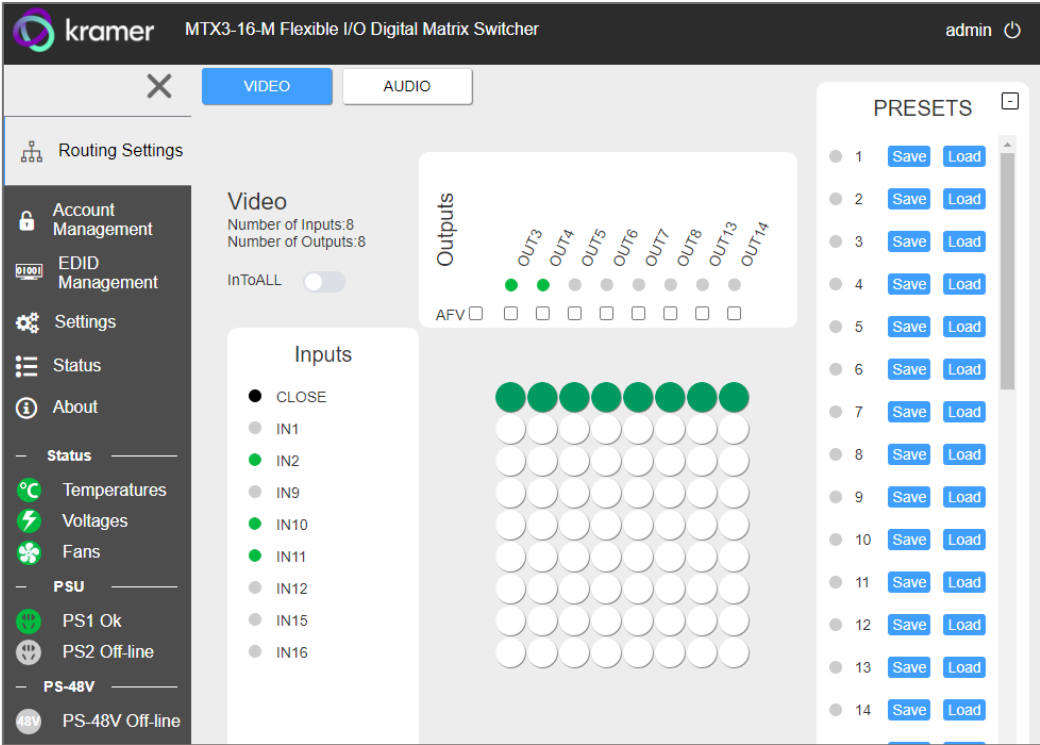

Figure 29: Main Landing Page with Navigation Pane



A green indicator (●) next to an input, indicates that an active signal is present on that input.

A green indicator (●) next to an output, indicates that an output device is detected.

- 5. Click the Navigation Pane on the left side of the screen to access the relevant web page.



Click X next to the VIDEO button to hide the navigation pane.

Logging off the Web-UI

To logoff from the webpages:

- 1. Click the  logo in the top right corner of the page.
- 2. Confirm that you want to exit.

Routing Inputs to Outputs

Use the embedded web UI to route (switch) inputs to outputs:

- [Routing Video Inputs to Outputs](#) on page 34.
- [Routing Audio Inputs to Outputs](#) on page 37.
- [Storing and Recalling Presets](#) on page 40.
- [Viewing / Configuring Port Settings](#) on page 40.

Routing Video Inputs to Outputs

Use the MTX3-16-M web UI to switch video inputs to the selected outputs:

- [Routing a Video Input to an Output](#) on page 34.
- [Routing a Video Input to All Outputs](#) on page 35.
- [Configuring AFV \(Audio Follow Video\)](#) on page 36.
- [Disconnecting Video Outputs](#) on page 37.

Routing a Video Input to an Output

To route the video inputs to the outputs:

1. Go to the Routing Settings page.
2. Click **VIDEO**. The video page appears, showing the available input/output ports.

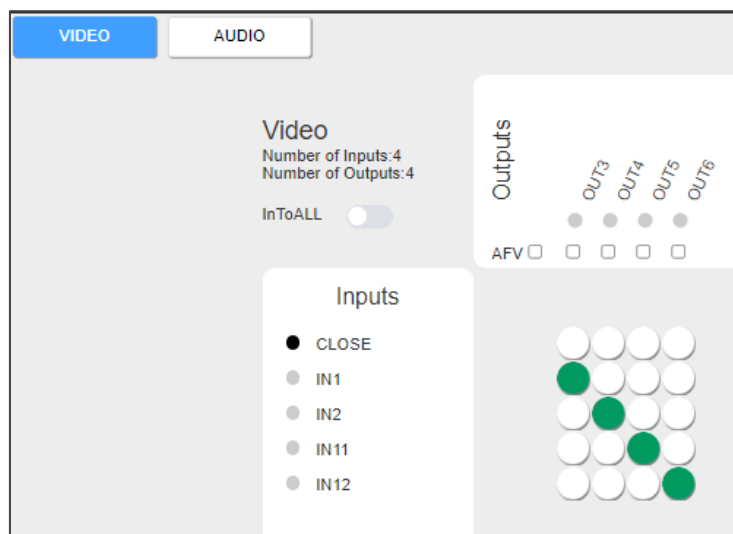

Figure 30: Video Routing Page

3. Click an Input/Output cross-point. For example, click IN2 to OUT3.

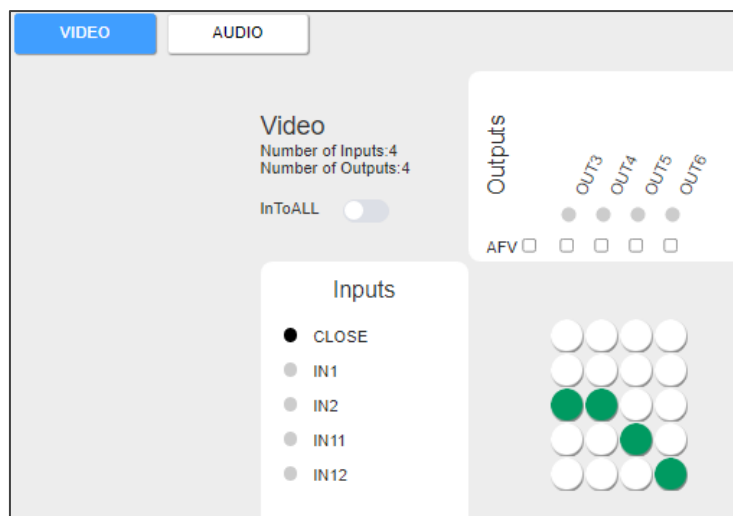

Figure 31: IN2 routed to OUT3

Video inputs are routed to the outputs.

Routing a Video Input to All Outputs

Use the MTX3-16-M web UI to switch video inputs to all the outputs.

To switch a video input to all outputs:

- 1. Go to the Routing Settings page.
- 2. Click **InToALL**. An ALL series of checkboxes appears under the OUT ports and a column of white circles appear beside the IN ports. The other cross-points are grayed out.

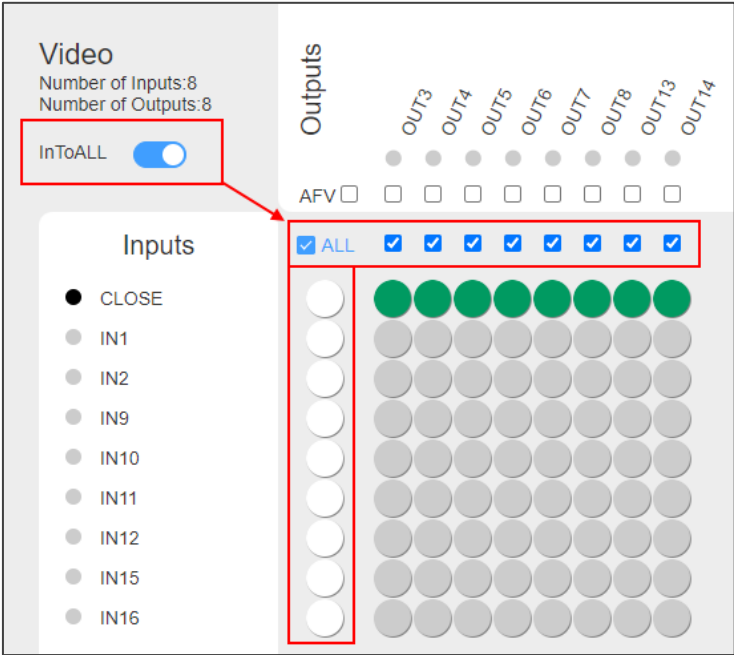

Figure 32: Routing Settings Page – InToALL Enabled

- 3. Click one of the white circles under the ALL checkbox (for example, IN1).
IN1 is routed to all the outputs.

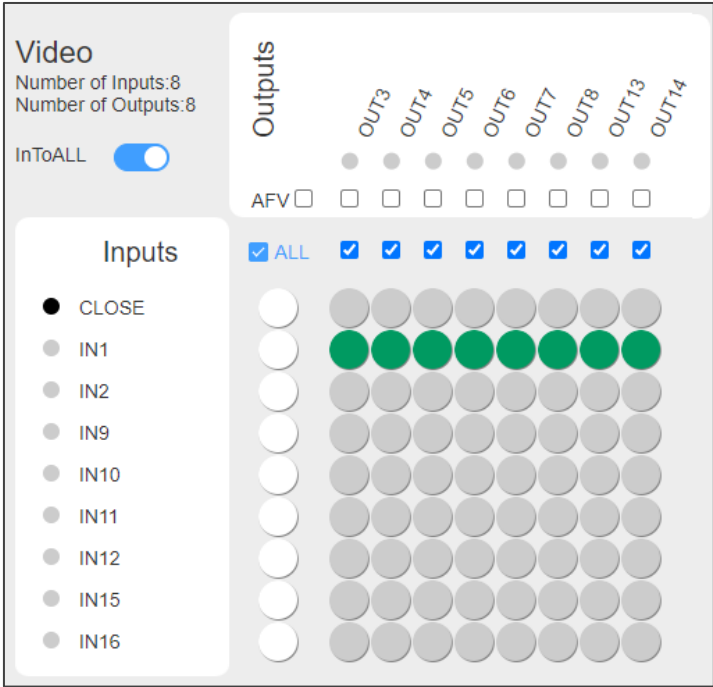

Figure 33: Routing Settings Page – IN1 Switched to All Outputs

- Select/deselect the relevant checkboxes to switch the selected input to specific outputs only.
- Set off the InToALL slider to return to normal switching mode.

The selected input is routed to all the outputs.

Configuring AFV (Audio Follow Video)

Use the **MTX3-16-M** embedded web UI to AFV mode so that whenever you switch the video, the audio switches with it.

To configure AFV:

- 1. Go to the **Routing Settings** page.
- 2. Select the **AFV** checkbox.

All AFV checkboxes are selected and audio switching for all inputs is configured to follow video switching.

- The AUDIO cross-points are disabled.

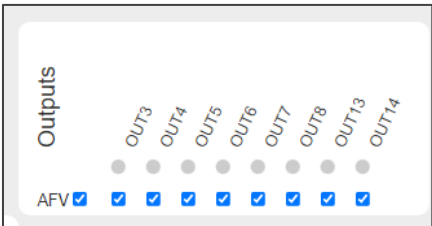



Figure 34: Routing Settings Page – Enabling AFV (audio follow video)

 To configure only specific audio outputs to follow video, select the relevant AFV checkboxes.

Disconnecting Video Outputs

Use the **MTX3-16-M** embedded web UI to disconnect outputs, so they are not connected to any input.

To disconnect an output:

1. Go to the Routing Settings page.
2. Check a cross-point in the CLOSE row that corresponds to the output that you want to turn off.

 To turn off all outputs, click **InToALL** and click the circle under the ALL checkbox that corresponds to CLOSE ([Figure 32](#)).

The selected output is turned off.

Routing Audio Inputs to Outputs

Use the **MTX3-16-M** web UI to switch audio inputs to the selected outputs:

- [Routing an Input to an Output](#) on page [37](#).
- [Routing an Audio Input to All Outputs](#) on page [38](#).
- [Disconnecting Audio Outputs](#) on page [39](#).

Routing an Input to an Output

To route the audio inputs to the outputs:

1. Go to the Routing Settings page.
2. Click **AUDIO**. The audio page appears, showing the available input/output ports.

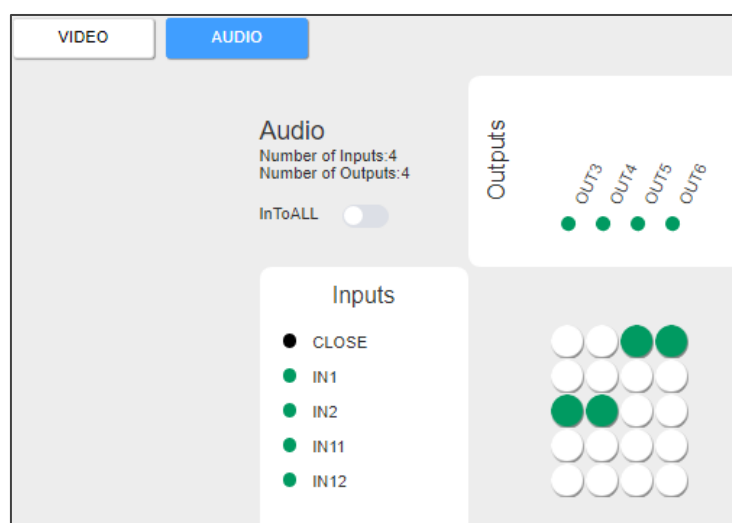

Figure 35: Audio Routing Page

3. Click an Input/Output cross-point. For example, click IN1 to OUT4.

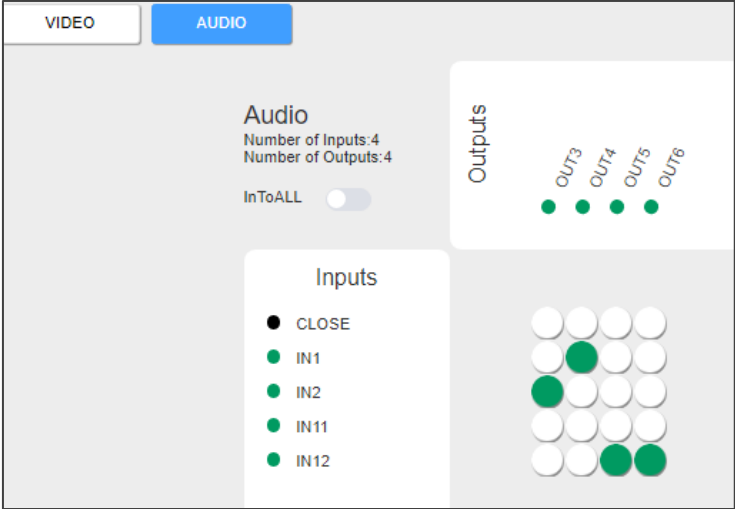

Figure 36: IN2 routed to OUT3

Audio inputs are routed to the outputs.

Routing an Audio Input to All Outputs

Use the **MTX3-16-M** web UI to switch video inputs to all the outputs.

To switch a video input to all outputs:

1. Go to the Routing Settings page.
2. Click **InToALL**. An ALL series of checkboxes appears under the OUT ports and a column of white circles appear beside the IN ports. The other cross-points are grayed out and disabled.

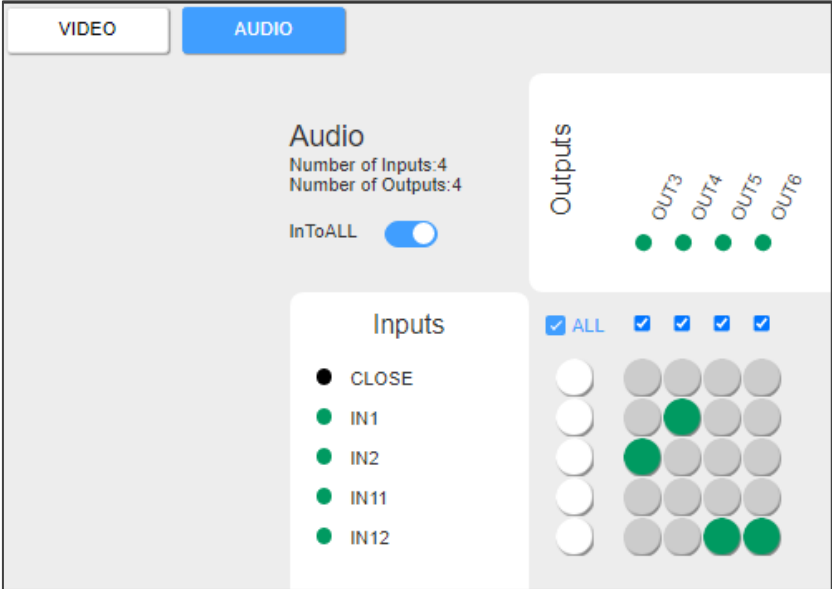

Figure 37: Routing Settings Page – InToALL Enabled

- Click one of the white circles under the ALL checkbox (for example, IN2).
IN2 is switched to all the outputs.

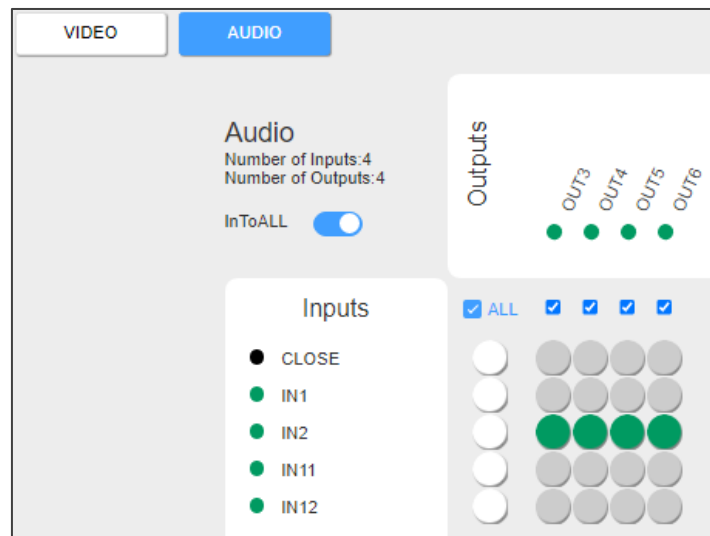



Figure 38: Routing Settings Page – IN2 Routed to All Outputs

-  Select/deselect the relevant checkboxes to route the selected input to specific outputs only.
-  Set off the InToALL switch to return to normal switching mode.

The selected input is routed to all the outputs.

Disconnecting Audio Outputs

Use the **MTX3-16-M** embedded web UI to disconnect outputs, so they are not connected to any input.

To disconnect an output:

- Go to the Routing Settings page.
- Check a cross-point in the CLOSE row that corresponds to the output that you want to turn off.

-  To turn off all outputs, click **InToALL** and click the circle under the ALL checkbox that corresponds to CLOSE ([Figure 32](#)).

The selected output is turned off.

Storing and Recalling Presets

Use the **MTX3-16-M** web-UI to store and recall up to 60 different video and audio input/output connection scenarios. A green dot indicates that the preset is storing a connection scenario.

To store the current input/output connection scenario as a preset:

1. Go to the Routing Settings page and set the desired connection scenario.

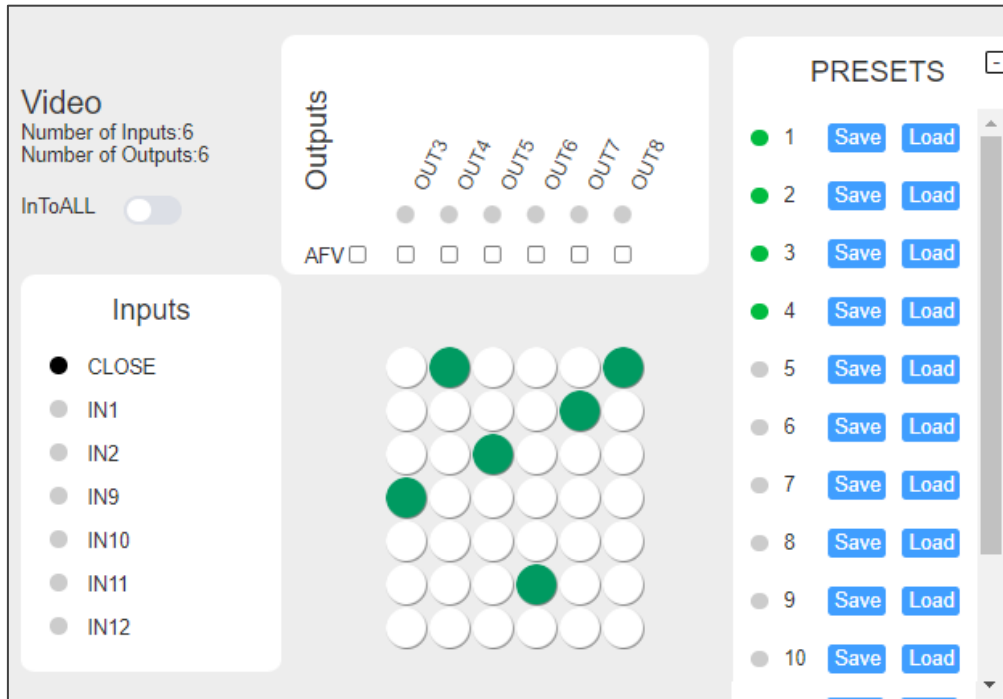

Figure 39: Routing Settings Page – Presets

2. Under PRESETS, click **Save** to save the connection scenario to a preset (1 to 60).
The current video and audio input/output configuration is stored.

To recall a stored preset:

- Under PRESETS, click **Load** next to the desired preset number (1 to 60) that you would like to recall.

The preset is recalled and the input/output connection scenario changes to the selected preset.

Viewing / Configuring Port Settings

Use the **MTX3-16-M** Routing Settings web-UI page to view and configure settings for each matrix card (input or output).



The Port tab of the Settings page also shows the port information/configuration panel (see [Configuring Input / Output Ports](#) on page 48).

To configure settings for a port:

1. Click the relevant input or output port in the Inputs of Outputs list of the Routing Settings page (for example IN2).

The Information panel for viewing the current configuration of the selected port appears.

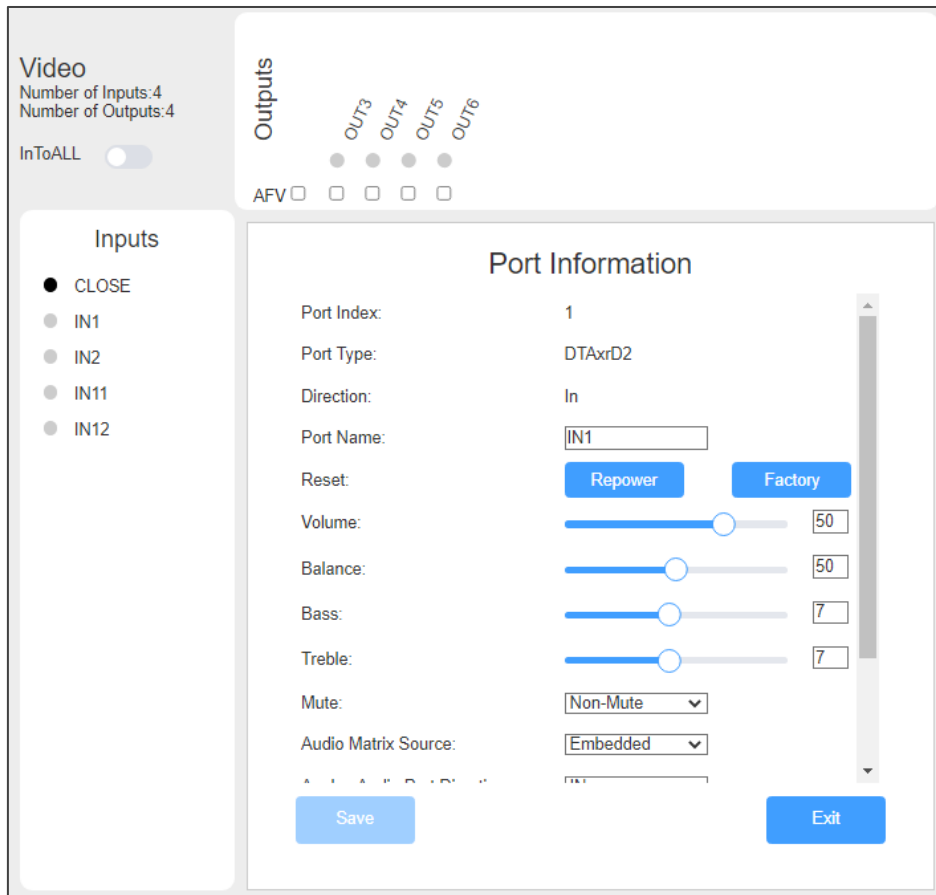

Figure 40: Viewing Port Information



The available port configuration attributes depend on the selected type of matrix card and the port direction (in/out), see [DTAxrD2-IN2-F34 / DTAxrD2-OUT2-F34 / DTAxrD2P-OUT2-F34](#) on page [62](#).

Port Information is viewed.

Defining User Accounts

Use the **MTX3-16-M** web UI to enable the administrator account (admin) to create up to 5 additional accounts with lower authorization.
there can be only one administrator account.



Performing factory resets from the Front Panel does not reset or delete the webpage accounts or their passwords.

This section describes the following actions:

- [Understanding Account Permissions](#) on page [42](#).
- [Creating or Deleting User Accounts](#) on page [43](#).



Understanding Account Permissions

Account permissions require usernames and passwords. The following are the user and password requirements as well as permission levels definition.

	Function
Administrator Defaults:	(see Default Communication Parameters on page 67)
Username requirements:	<ul style="list-style-type: none"> Length of 4 to 20 characters, lowercase only (a to z), numbers are allowed and underscores “_” and minus “-”. Usernames cannot contain the word “admin”.
Password requirements:	<ul style="list-style-type: none"> Length of 8 to 12 characters, upper and lowercase are permitted. The password must contain a letter, number and special character (@, \$, !, %, *, ?, &). Only the administrator account can change passwords.

Account permission levels:

The following table illustrates account permission levels:

Account type 	Administrator	Manager	Operator
Permission levels 			
Create new accounts	Yes	No	No
Change Passwords	Yes	No	No
Update firmware & load a configuration file	Yes	Yes	No
Update settings, change routing etc.	Yes	Yes	Yes

Creating or Deleting User Accounts

Only the web UI's administrator account can create or delete user accounts and modify passwords.



You can add up to 5 users.

To add an account:

1. Open the Account Management page.

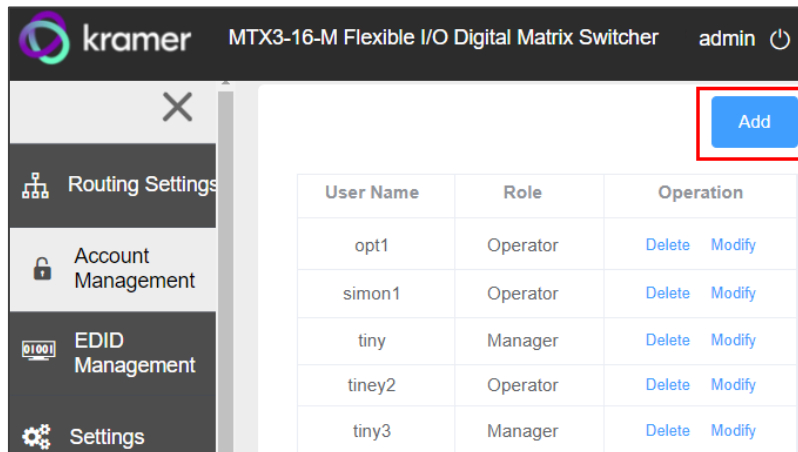

Figure 41: Adding a User Account

2. Click **Add**.
3. Enter a username, select a role (operator or manager) and enter an initial password.

For username rules, role permissions and password rules, (see [Understanding Account Permissions](#) on page 42).

Acquiring EDID

Use the **MTX3-16-M** web UI to copy an EDID from any input/output, custom file, or the default EDID to any input.

To copy an EDID:

1. Go to the EDID Management page.

The screenshot shows the EDID Management Page interface. It is titled "EDID" and is organized into three main columns:

- Read From:** This column is split into "Outputs" (OUT3, OUT4, OUT5, OUT6) and "Inputs" (IN1, IN2, IN11, IN12). Below these are "DEFAULT" and "File BROWSE" buttons.
- Short Summary:** This column displays the selected EDID: "MTX3-DTArD2" with resolution "1920*1080", "2 channels Audio", and a size of "256". Below this, it indicates "FROM IN1" and "Select a destination".
- Copy to:** This column has a checkbox for "All" and four input buttons: IN1, IN2, IN11, and IN12.

Figure 42: EDID Management Page

2. Click an input or output in the **Read From** area.
-OR-
Click **DEFAULT** to use the default EDID.
-OR-
Click **File BROWSE** to select a custom EDID file.
3. Click all relevant Inputs in the **Copy to** area or select the **All** checkbox to copy to all inputs.
4. Click **COPY**.
The selected EDID is copied to all selected inputs.

Configuring MTX3-16-M

Use the **Settings page > Device tab** to view device model and serial number, configure network settings, upgrade the **MTX3-16-M** firmware, save configurations and reset the device:

- [Updating Network Parameters](#) on page [45](#).
- [Upgrading Firmware](#) on page [46](#).
- [Saving or Loading a Device Configuration File](#) on page [46](#).

Updating Network Parameters

To view or update network settings:

1. Go to the **Settings** page, (default) **Device** tab.

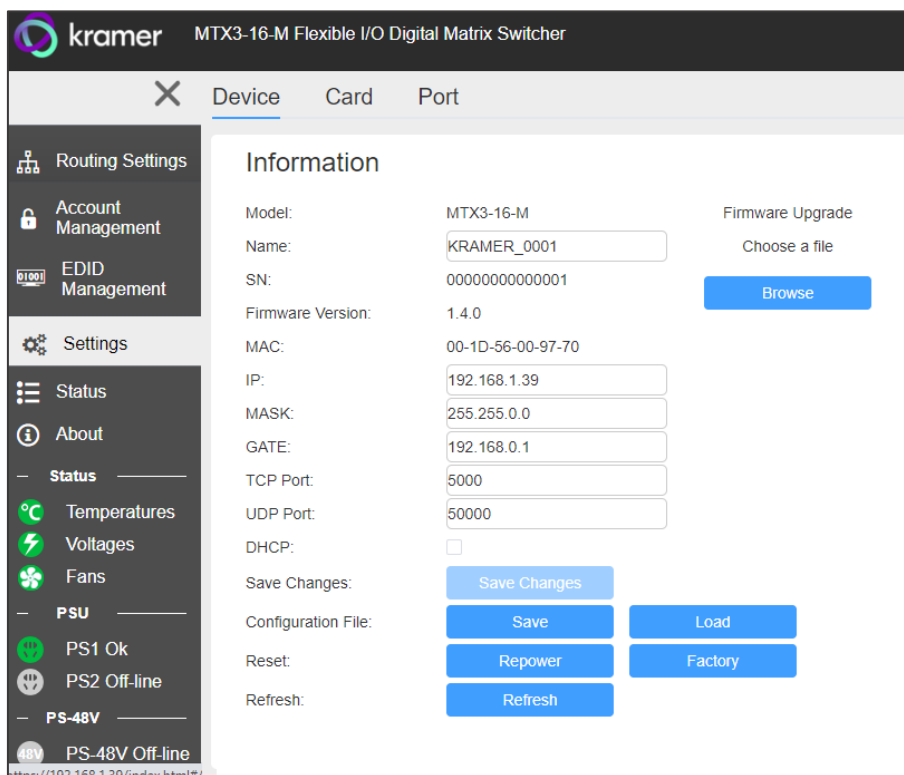

Figure 43: Settings Page – Device Configuration

2. View or update the device Name.
3. Change network settings as required:
 - IP (address of ETH0/Net-1 (23))
 - Mask, Gate (address of ETH1/NET2-1G (24))
 - TCP port number.
 - UDP port number.
4. Enable/disable DHCP address resolution on all cards inserted into the matrix.
5. Click Save Changes.

Device Settings are configured.

Upgrading Firmware



This option is available only for administrator and manager accounts.

To upgrade the MTX3-16-M firmware:

1. Go to the **Settings** page > **Device** tab.
2. Click **Browse** (top right), select a new firmware file.
3. Click **Open**. The firmware file opens.
4. follow the online instructions and wait for update completion.
5. Click **Repower** to reboot the device
6. Click **Refresh** to refresh the web page.

Firmware is updated.

Saving or Loading a Device Configuration File

Use the **MTX3-16-M** web UI to export and back-up configuration settings to a JSON file for future use.

The exported configuration file includes routing information, EDID data, matrix card details and settings, and port details and settings. User account information is not exported.



These options are only displayed for administrator and manager accounts.

To export or import the MTX3-16-M configuration file:

1. Go to the **Settings** page > **Device** tab.
2. Select an option:
 - Click **Save** and select a destination for the file to export a configuration file. The configuration file is saved in your Download folder.
 - Click **Load** to import a (previously saved) configuration file and continue to the next step.
3. Select a file to import.
4. Confirm that you want the **MTX3-16-M** settings to be replaced.

MTX3-16-M restarts, using the imported configuration file parameters.

Resetting MTX3-16-M

To reset or reset device parameters to their default value MTX3-16-M:

1. Go to the **Settings** page > **Device** tab.
2. Select an option:
 - To restart MTX3-16-M: Click **Repower** (near bottom).
 - To restore factory defaults: Click **Factory**.
3. Click to confirm the selected option.

MTX3-16-M is reset.

Upgrading / Restoring Module Card Firmware

The **Settings** page's **Card** tab has a **Card List**, showing the matrix cards currently inserted into the MTX3-16-M. Click on a Slot to view that matrix card's type, model, video direction (in or out) and firmware version.

This page enables the following actions:

- [Restoring Matrix Cards to Factory Defaults](#) on page [47](#).
- [Upgrading Matrix Card Firmware](#) on page [48](#).

Matrix cards have a unique name that appears in the web UI, as summarized in [Matrix Card UI Names](#) on page [58](#).

Restoring Matrix Cards to Factory Defaults

1. Go to the **Settings** page, **Card** tab.

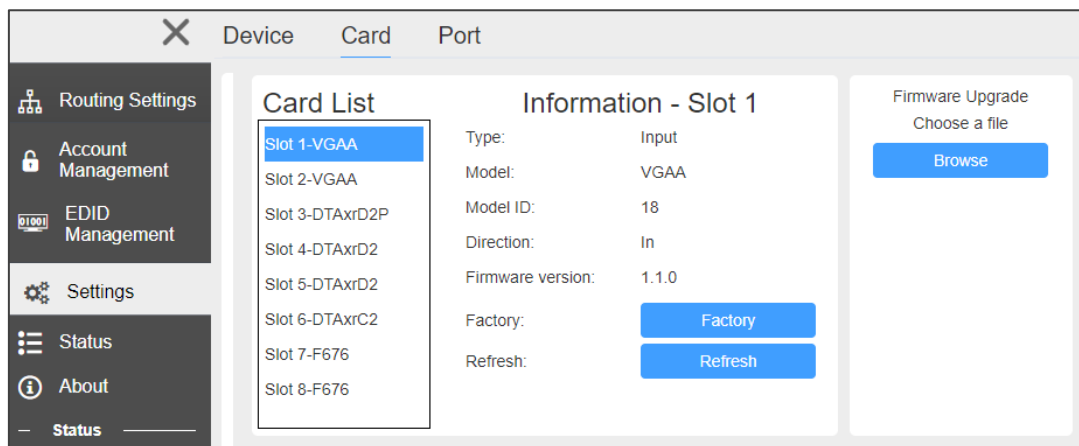

Figure 44: Settings Page – Card Configuration

2. Click **Factory**.
3. A prompt asks you to confirm your choice.

Factory settings are restored on the inserted card.

Upgrading Matrix Card Firmware



When upgrading the firmware of a matrix card via web pages, we recommend that you close other open accounts and ensure that only one current manager or administrator account is open online.

To upgrade the Matrix MTX3-16-M firmware:

1. Go to the **Settings** page > **Card** tab.
2. Click **Browse** (top right), select a new firmware file.
3. Click **Open**. The firmware file opens.
4. Follow online instructions.
5. Wait for firmware upgrade completion.

Matrix card firmware is complete.

Configuring Input / Output Ports

Use the **MTX3-16-M** web UI to edit module card port settings, to restore a port to its factory default settings and to repower (restart) it.

Matrix cards have a unique name that appears in the web UI, as summarized in [Matrix Card UI Names](#) on page 58.

To configure settings for a port:

1. On the **Port** tab of the **Settings** page, select a port in the **Port List**.
2. The Information pane for the selected port appears. The available configuration attributes depend on the type of selected matrix card and port direction (in or out) (see [DTAxrD2-IN2-F34 / DTAxrD2-OUT2-F34 / DTAxrD2P-OUT2-F34](#) on page 62) .

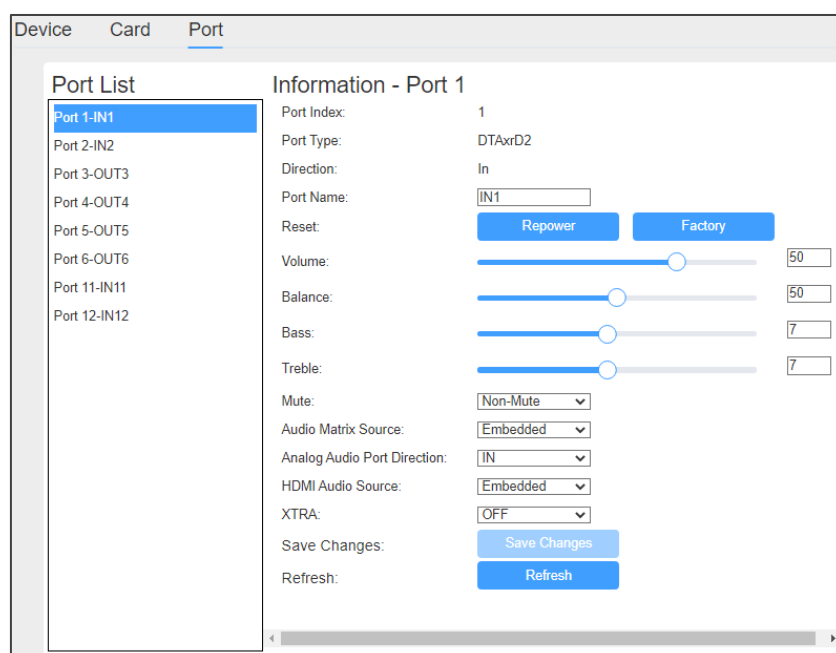

Figure 45: Settings Page > Port Tab > Port Information Panel

3. Configure settings as needed.
4. Click **Save Changes** to implement your update.



You can also access a port information/configuration panel by clicking the port name in the Routing Settings page (see [Routing Inputs to Outputs](#) on page 33).

Setting HDBT Range



These settings apply to the following input/output cards:

- DTAxrC2-IN2-F34 / DTAxrC2-OUT2-F34
- DTAxrD2-IN2-F34 / DTAxrD2-OUT2-F34
- DTAxrD2P-OUT2-F34

To set HDBT range:

- On the Port Information panel, under XTRA, select one of the following:
 - **ON** – HDBaseT ultra-long range (to enable increased range at a reduced bandwidth).
 - **OFF** – HDBaseT standard range.



Actual ranges depend on the resolution of signal. See the card technical specifications for more information.

Port List	Information - Port 11
Port_In 1-IN1	Port Index: 11
Port_In 2-IN2	Port Type: 2xHDMI-AUD
Port_In 25-IN25	Direction: Out
Port_In 26-IN26	Port Name: <input type="text" value="OUT11"/>
Port_In 29-IN29	Color Space: <input type="text" value="Auto"/>
Port_In 30-IN30	Reset: <input type="button" value="Repower"/> <input type="button" value="Factory"/>
Port_In 31-IN31	Volume: <input type="range" value="50"/>
Port_In 32-IN32	Balance: <input type="range" value="50"/>
Port_Out 9-OUT9	Bass: <input type="range" value="7"/>
Port_Out 10-OUT10	Treble: <input type="range" value="7"/>
Port_Out 11-OUT11	Mute: <input type="text" value="Non-Mute"/>
Port_Out 12-OUT12	Mono: <input type="text" value="OFF"/>
Port_Out 15-OUT15	ARC Enabled: <input type="text" value="OFF"/>
Port_Out 16-OUT16	Analog Audio Port Direction: <input type="text" value="OUT"/>
Port_Out 21-OUT21	Analog Audio Port Source: <input type="text" value="Embedded"/>
Port_Out 22-OUT22	HDMI Audio Source: <input type="text" value="Auto"/>
Port_Out 25-OUT25	Save Changes: <input type="button" value="Save Changes"/>
Port_Out 26-OUT26	Refresh: <input type="button" value="Refresh"/>
Port_Out 29-OUT29	
Port_Out 30-OUT30	
Port_Out 31-OUT31	
Port_Out 32-OUT32	

Figure 46: Settings Page > Port Tab > Port Information Pane with HDBaseT

Configuring Compression Level



These settings apply to the following input/output cards:

- DTAxrC2-IN2-F34 / DTAxrC2-OUT2-F34

To configure compression level:

- On the Port Information pane, under XTRA, select one of the following:
 - **Standard**
 - **High**

Configuring Compression Resolution

These settings apply to the following input/output cards:

- DTAxrC2-IN2-F34 / DTAxrC2-OUT2-F34

To configure compression level:

- On the Port Information panel, under XTRA, select one of the following:
 - **>1080P** – Compress signal resolutions higher than 1080p.
 - **ALL** – Compress all signal resolutions to enable extended reach.

Monitoring MTX3-16-M Hardware

If the **Real Time Clock (RTC)** battery dies, **do not replace the battery yourself**. Contact Kramer support.

This page enables performing the following actions:

- [Monitoring Temperatures](#) on page [51](#).
- [Monitoring Voltages](#) on page [51](#).
- [Monitoring Port PoE Providing](#) on page [52](#).
- [Monitoring Fans Status](#) on page [52](#).

Use the **MTX3-16-M** web UI to monitor the status of the control card and matrix cards.

The Status Information Panel –

The left panel on the web pages has a status information area. If the panel is hidden, by clicking the X (at the top), the (green) icons remain visible and will turn red if a problem is detected.

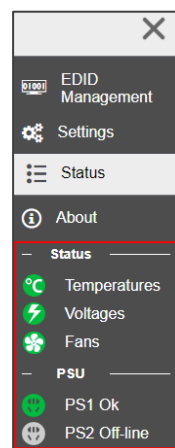

Figure 47: Status Information Panel – Temperature Status

Monitoring Temperatures

To review the temperature status:

1. Open the Status page > **Temperatures** tab.

Temperatures			
Name	Max(°C)	Value(°C)	Status
Control Board	75.00	35.50	OK
Slot_1 (DTAxD2)	75.00	38.05	OK
Slot_2 (DTAxD2P)	75.00	47.00	OK
Slot_3 (DTAxD2)	75.00	35.00	OK
Slot_6 (DTAxC2)	75.00	38.05	OK
Environment Monitor	60.00	43.00	OK

Figure 48: Temperatures Status Page

2. View the temperature status.

The Temperatures tab lists the cards inserted into the slots. Each line shows the inserted card's maximum permitted temperature (**Max**) and current temperature (**Value**). If a card has a temperature problem, **Status** will show a **WARN** message and the Status panel's "Temperatures" icon will be red.

Monitoring Voltages

1. Open the Status > **Voltages** tab.

Temperatures			
Voltages			
Name	Standard value(V)	Value(V)	Status
Slot_1 (DTAxD2)	12.00	12.26	OK
Slot_2 (DTAxD2P)	12.00	12.00	OK
Slot_3 (DTAxD2)	12.00	12.22	OK
Slot_6 (DTAxC2)	12.00	12.39	OK

Figure 49: Voltages Status Page

2. View the voltage status.

The tab lists the cards inserted into slots, the voltage each card requires (**Standard value**), and the actual voltage received (**Value**).

If one of the cards has a voltage problem, **Status** will show a **WARN** message and the Status panel will show a red voltage icon.

Monitoring Port PoE Providing

1. Open the Status page > **Port-POE** tab.

Name	Port1	Port2
Slot_3 (DTAvrC2)	Off	Off
Slot_5 (DTAvrC2)	On	On
Slot_13 (DTAvrC2)	Off	Off

Figure 50: Status page – Port-POE Tab

2. View Port-POE status

The tab lists the inserted matrix cards which have HDBT ports supporting PoE providing. Ports which provide PoE show a green RJ-45 icon, ports which do not provide PoE show a black icon.

Monitoring Fans Status

All fans have the same level value, and all fans automatically adjust the speed once every 60 seconds according to the max temperature:

- If the maximum temperature is greater than 55°C (max > 55°C), all fans directly go to Level_7.
- If the maximum temperature is between 50°C and 55°C, all fans gradually increase to maximum Level_7.
- If the maximum temperature is between 45°C and 50°C, all fans remain unchanged.
- If the maximum temperature is less than 45°C, all fans gradually decrease to the minimum (Level_1).

To review the fan status

1. Open the Status page > **Fan** tab.
2. View Fan Status.

The tab lists the fans and the level at which they are operating. If one of the fans has a problem, there will be a warning in the **Status** column.

Name	Value(Level_1~7)	Status
Fan_1	Level_1	OK
Fan_2	Level_1	OK
Fan_3	Level_1	OK

Figure 51: Status Page – Fans Tab

Viewing the about Page

Click **About** to access the about page which shows the web version and Kramer information.



Figure 52: About Page

Upgrading Firmware

MTX3-16-M firmware can be upgraded in the following methods:

- Using the embedded web UI, see [Upgrading Firmware from the Web UI](#) on page 54.
- Using K-Upload to communicate through the USB port ①, over an ethernet connection or using an RS-232 connection, see [Upgrading Firmware – K-Upload](#) on page 54.
- Via Protocol 3000 commands (see [Protocol 3000 Commands](#) on page 70) .

Upgrading Firmware from the Web UI

To upgrade MTX3-16-M chassis firmware using the embedded web UI:

1. In the Settings page, Device tab, click **Browse**.
2. Select the relevant upgrade file.
3. You will be asked to confirm before the upgrade runs.

To upgrade the firmware of one of the matrix cards via the embedded web UI:

1. In the Settings page, Card tab, click **Browse**.
2. Select the relevant upgrade file.
3. You will be asked to confirm before the upgrade runs.

Upgrading Firmware – K-Upload

MTX3-16-M enables upgrading device and card firmware via RS-232, USB (VCOM) or Ethernet using the K-Upload software application, available at http://www1.kramerav.com/support/product_downloads.asp.

The latest version of **K-UPLOAD** and installation instructions can be downloaded from our website at: http://www1.kramerav.com/support/product_downloads.asp.



When using the micro USB port, install the Kramer USB driver, available at: <https://k.kramerav.com//support/download.asp>.

To Upgrade the firmware:

1. Download and run K-UPLOAD.
2. In the **K-Upload** screen, click **Connect**.
3. In the **Connection Method** dialog, select the method by which you want to communicate with the **MTX3-16-M**.
4. Click **Browse** and find the firmware file (for example, MTX3-XX-M _1.4.0.kptw).
5. Click **Upload**.

6. **MTX3-16-M** will automatically restart and K-Upload will show an Upgrade success or failed message.

In the Settings webpage, Device tab, check that the firmware version was updated.

Technical Specifications

MTX3-16-M CNTL and Chassis

CNTL Card		
Ports	1Gbp Ethernet	On RJ-45 female connector for matrix LAN connection
	100Mbps Ethernet	On RJ-45 female connector for matrix service
	RS-232	On 3-pin terminal block for local service.
RS-232	Baud Rate	9600/19200/38400/57600/112500 (default)
	Character Frame	8 bit / No parity / 1 Stop bit / ASCII
Chassis		
Ports	USB	Mini-USB connector for firmware upgrade.
Backplane Data Rate Per Port	AV	50Gbps
	Ethernet	1Gbps
Card Slots	Central Control	1
	I/O	8
Modules	Power	1 Matrix power supply 1 PoE power supply
	Fan	1
Power	Consumption	100-240V AC, 50/60Hz, 2.2A
Environmental Conditions	Operating Temperature	0° to + 40°C (32° to 104°F)
	Storage Temperature	-45° to +72°C (-49° to 162°F)
	Humidity	10% to 90%, RHL non-condensing
	Cooling	Forced air, 3 fans
Regulatory Compliance	Safety	CE
	Environmental	RoHs and WEEE
Accessories	Included	2 Power cords Rack ears for rack mounting
	Optional	For optimum range and performance use recommended Kramer cables available at: www.kramerav.com/product/MTX3-16-M
Enclosure	Material	Aluminum
Product	Net Dimensions (W, D, H)	43.7cm x 18.4cm x 8.8cm (17.2" x 7.2" x 3.5") 19" 3U
	Net weight	7.45kg (16.4lbs) approx.
Shipping	Dimensions (W, D, H)	58cm x 53.5cm x 21.5cm (22.8" x 21.1" x 8.5")
	Weight	9.3kg (20.5lbs) approx.
	Vibration	ISTA 1A in carton (International Safe Transit Association)

MTX3-34-M CNTL and Chassis

CNTL Card		
Ports	1Gbp Ethernet	On RJ-45 female connector for matrix LAN connection
	100Mbps Ethernet	On RJ-45 female connector for matrix service
	RS-232	On 3-pin terminal block for local service.
RS-232	Baud Rate	9600/19200/38400/57600/112500 (default)
	Character Frame	8 bit / No parity / 1 Stop bit / ASCII
Chassis		
Ports	USB	Mini-USB connector for firmware upgrade.
Backplane Data Rate Per Port	AV	50Gbps
	Ethernet	1Gbps
Card Slots	Central Control	1
	I/O	17
Modules	Power	2 Matrix power supplies: 1 included, 2 nd one is optional and is not included 1 PoE Power Supply (optional, not included)
	Fan	1
Power	Consumption	100-240V AC, 50/60Hz, 5.2A
Environmental Conditions	Operating Temperature	0° to +40°C (32° to 104°F)
	Storage Temperature	-45° to +72°C (-49° to 162°F)
	Humidity	10% to 90%, RHL non-condensing
	Cooling	Forced air, 3 fans
Regulatory Compliance	Safety	CE
	Environmental	RoHs and WEEE
Accessories	Included	Power cord, rack ears for rack mounting
Enclosure	Material	Aluminum
Product	Net Dimensions (W, D, H)	43.7cm x 36 cm x 17.7cm (17.2" x 14.2" x 7") 19" 4U
	Net weight	6.7kg (14.8lbs) approx.
Shipping	Dimensions (W, D, H)	57cm x 48cm x 28cm (22.4" x 18.9" x 11")
	Weight	8kg (17.6lbs) approx.
	Vibration	ISTA 1A in carton (International Safe Transit Association)

Matrix Cards

This section describes the Matrix cards unique names as they appear in the web UI (see [Matrix Card UI Names](#) on page 58), as well as the matrix card specs for:

- [MC3-2Hi / H2-IN2-F34 / MC3-2Ho / H2-OUT2-F34](#) on page 59.
- [MC3-2HAi / H2A-IN2-F34 / MC3-2HAo / H2A-OUT2-F34](#) on page 60.
- [MC3-2Ri / DTAxrC2-IN2-F34 / MC3-2To / DTAxrC2-OUT2-F34](#) on page 61.
- [DTAxrD2-IN2-F34 / DTAxrD2-OUT2-F34 / DTAxrD2P-OUT2-F34](#) on page 62.
- [F676-IN2-F34 / F676-OUT2-F34](#) on page 63.
- [VGAA-IN2-F34 / VGAA-OUT2-F34](#) on page 63.
- [SDIA-IN2-F34](#) on page 64.
- [MC3-2S-2S](#) on page 64.
- [MC3-2F-2F](#) on page 65.
- [MC3-2H-2T / MC3-2R-2H](#) on page 66.

Matrix Card UI Names

Matrix Card	UI Name	Matrix Card	UI Name
VGAA-IN2-F16	VGAA	F676-IN2-F34	F676
VGAA-OUT2-F16	VGAA	F676-OUT2-F34	F676
SDIA-IN2-F16	SDIA	MC3-2Hi	2xHDMI
H2-IN2-F34	H2	MC3-2Ho	2xHDMI
H2-OUT2-F34	H2	MC3-2HAi	2xHDMI-AUD
H2A-IN2-F34	H2A	MC3-2HAo	2xHDMI-AUD
H2A-OUT2-F34	H2A	MC3-2Ri	2xHDBT-AUD
DTAxrC2-IN2-F34	DTAxrC2	MC3-2To	2xHDBT-AUD
DTAxrC2-OUT2-F34	DTAxrC2	MC3-2S-2S	2S-2S
DTAxrD2-IN2-F34	DTAxrD2	MC3-2F-2F	2F-2F
DTAxrD2-OUT2-F34	DTAxrD2	MC3-2R-2H	2R-2H
DTAxrD2P-OUT2-F34	DTAxrD2P	MC3-2H-2T	2H-2T

MC3-2Hi / H2-IN2-F34 / MC3-2Ho / H2-OUT2-F34

- **MC3-2Hi / H2-IN2-F34:** 2 HDMI inputs.
- **MC3-2Ho / H2-OUT2-F34:** 2 HDMI outputs.

Inputs/Outputs	2 HDMI	On female HDMI connectors
Video	Max Data Rate	18Gbps (6Gbps per graphics channel)
	Max Resolution	4K@60Hz (4:4:4)
	Max Switching Time Between Inputs	7.5 seconds Note: Assuming typical display with up to 3sec delay time contribution
	Output Transition on Switching	Black/Blue screen
	HDMI Standard	2.0
	Content Protection	HDCP 2.2/1.4 compliant
	Power	Consumption
Environmental Conditions	Operating Temperature	0° to +40°C (32° to 104°F)
	Storage Temperature	-40° to +70°C (-40° to 158°F)
	Humidity	10% to 90%, RHL non-condensing
Regulatory Compliance	Safety	CE
Product	Net Dimensions (W, D, H)	12.90cm x 24.90cm x 2.00cm (5.08" x 9.80" x 0.79")
	Net weight	0.2kg (0.5lbs) approx.
Shipping	Dimensions (W, D, H)	16.50cm x 34.50cm x 5.90cm (6.50" x 13.58" x 2.32")
	Weight	0.4kg (0.9lbs) approx.

MC3-2HAi / H2A-IN2-F34 / MC3-2HAo / H2A-OUT2-F34

- **MC3-2HAi / H2A-IN2-F34:** 2 HDMI inputs with 2 analog audio ports.
- **MC3-2HAo / H2A-OUT2-F34:** 2 HDMI outputs with 2 analog audio ports.

Inputs/Outputs	2 HDMI	On female HDMI connectors
Ports	2 Analog Audio	On 3.5mm mini jacks
Video	Max Data Rate	18Gbps (6Gbps per graphics channel)
	Max Resolution	4K@60Hz (4:4:4)
	Max Switching Time Between Inputs	7.5 seconds Note: Assuming typical display with up to 3sec delay time contribution
	Output Transition on Switching	Black/Blue screen
	HDMI Standard	2.0
	Content Protection	HDCP 2.2/1.4 compliant
Power	Consumption	5W
Environmental Conditions	Operating Temperature	0° to +40°C (32° to 104°F)
	Storage Temperature	-40° to +70°C (-40° to 158°F)
	Humidity	10% to 90%, RHL non-condensing
Regulatory Compliance	Safety	CE
Product	Net Dimensions (W, D, H)	12.90cm x 24.90cm x 2.00cm (5.08" x 9.80" x 0.79")
	Net weight	0.2kg (0.5lbs) approx.
Shipping	Dimensions (W, D, H)	16.50cm x 34.50cm x 5.90cm (6.50" x 13.58" x 2.32")
	Weight	0.4kg (0.9lbs) approx.

MC3-2Ri / DTAxrC2-IN2-F34 / MC3-2To / DTAxrC2-OUT2-F34

- **MC3-2Ri / DTAxrC2-IN2-F34:** 2 HDBT ports with 2 analog audio ports, 2 IR ports, 2 RS-232 ports and 1 Ethernet port.
- **MC3-2To / DTAxrC2-OUT2-F34:** 2 HDBT ports with 2 analog audio ports, 2 IR ports, 2 RS-232 ports and 1 Ethernet port.

Inputs/Outputs	2 HDBaseT	On RJ-45 connectors	
Ports	2 Unbalanced Audio	On a 6-pin terminal block connector	
	2 RS-232	On a 6-pin terminal block connector	
	2 IR	On a 4-pin terminal block connector	
	1 Ethernet	On an RJ-45 connector	
Extension Line	Standard Compression	Up to 100m (330ft) at 4K@60Hz (4:4:4), 4K@60Hz (4:2:0) or 4K@30Hz (4:4:4)	
		Up to 180m (590ft) at full HD (1080p @60Hz 24bpp)	
	High Compression	Up to 100m (330ft) at 4K@60Hz (4:4:4), or 4K@60Hz (4:2:0)	
		Up to 180m (590ft) at 4K@30Hz (4:4:4)	
		Up to 200m (650ft) at full HD (1080p @60Hz 24bpp)	
	No Compression	Up to 100m (330ft) at 4K@60Hz (4:2:0)	
Up to 180m (590ft) at full HD (1080p @60Hz 24bpp)			
Standards Compliance	HDBaseT 1.0		
Video	Max Data Rate	Up to 18Gbps (6Gbps per graphic channel), 10Gbps CSC over CAT cable	
	Max Resolution	Standard Compression	4096x2160@60Hz (4:4:4) 24bpp
		High Compression	3840x2160@60Hz (4:4:4) 24bpp
		No-Compression	4096x2160@60Hz (4:2:0) 24bpp
	Max Switching Time Between Inputs	7.5 seconds	
		Note: Assuming typical display with up to 3sec delay time contribution	
	Output Transition on Switching	Black/Blue screen	
Compliance	HDCP 2.2, HDR 10		
HDMI Standard	2.0		
Extended Ethernet	Bandwidth	Up to 100Mbps	
Extended RS-232	Baud Rate	300 to 115200	
Power	Consumption	21.5W	
Environmental Conditions	Operating Temperature	0° to +40°C (32° to 104°F)	
	Storage Temperature	-40° to +70°C (-40° to 158°F)	
	Humidity	10% to 90%, RHL non-condensing	
Regulatory Compliance	Safety	CE	
	Environmental	RoHs and WEEE	
Product	Net Dimensions (W, D, H)	13cm x 25cm x 2cm (5.2" x 10" x 1")	
	Net weight	0.3kg (0.7lbs) approx.	
Shipping	Dimensions (W, D, H)	16.50cm x 34.50cm x 5.90cm (6.50" x 13.58" x 2.32")	
	Weight	0.5kg (1.1lbs) approx.	

DTAxrD2-IN2-F34 / DTAxrD2-OUT2-F34 / DTAxrD2P-OUT2-F34

- **DTAxrD2-IN2-F34:** 2 HDBT ports with 2 analog audio ports, 2 IR ports, 2 RS-232 ports and 1 Ethernet port.
- **DTAxrD2-OUT2-F34:** 2 HDBT ports with 2 analog audio ports, 2 IR ports, 2 RS-232 ports and 1 Ethernet port.
- **DTAxrD2P-OUT2-F34:** 2 PoE-providing-enabled HDBT ports with 2 analog audio ports, 2 IR ports, 2 RS-232 ports and 1 Ethernet port.

Inputs/Outputs	2 HDBaseT	On RJ-45 connectors
Ports	2 Unbalanced Audio	On a 6-pin terminal block connector
	2 RS-232	On a 6-pin terminal block connector
	2 IR	On a 4-pin terminal block connector
	1 Ethernet	On an RJ-45 connector
Extension Line	Compression	Low-level standard DSC compression for signals above 4K@60 (4:2:0)
	4K@60 (4:4:4)	Range with Compression: Up to 100m (330ft)
	4K@60 (4:2:0)	Range with No Compression: Up to 100m (330ft)
	Full HD (1080p@60Hz)	Range with No Compression: Up to 130m (430ft)
		Range in Ultra-Long Mode: Up to 180m (590ft)
Standards Compliance	 When using recommended Kramer cables HDBaseT 2.0-	
Video	Max Bandwidth	With Compression: 17.95Gbps (5.98Gbps per graphic channel)
		With No Compression: 10.2Gbps (3.4Gbps per graphic channel)
	Max Resolution	With Compression: 3840x2160@60Hz 4:4:4 24bpp
		With No Compression: 4096x2160@60Hz 4:2:0 24bpp
HDMI Standard	2.0	
Compliance	Compliance: HDCP 2.2, HDR 10	
Extended Ethernet	Bandwidth	Up to 100Mbps
Extended RS-232	Baud Rate	300 to 115200
Power	Consumption	21.5W
Environmental Conditions	Operating Temperature	0° to +40°C (32° to 104°F)
	Storage Temperature	-40° to +70°C (-40° to 158°F)
	Humidity	10% to 90%, RHL non-condensing
Regulatory Compliance	Safety	CE
	Environmental	RoHs and WEEE
Product	Net Dimensions (W, D, H)	13cm x 25cm x 2cm (5.2" x 10" x 1")
	Net weight	0.2kg (0.5lbs) approx.
Shipping	Dimensions (W, D, H)	16.50cm x 34.50cm x 5.90cm (6.50" x 13.58" x 2.32")
	Weight	0.4kg (0.9lbs) approx.

F676-IN2-F34 / F676-OUT2-F34

- **F676-IN2-F34:** 2LC connectors with 2 RS-232 ports.
- **F676-OUT2-F34:** 2 LC connectors with 2 RS-232 ports.

Inputs/Outputs	2 Fiber Optic	On LC connectors
Ports	2 RS-232	On a 3-pin terminal block connector
Video	Max Bandwidth	18Gbps
	Max Resolution	4K@60 (4:4:4)
	HDMI Standard	2.0
	Content Protection	HDCP 2.2
Extension Line	Optical Fiber	Multi-mode (MM) or single-mode (SM)
	Optical Module	Kramer 10Gbps SFP+ IEEE 802.3ae compliant modules (MM is included)
Multi-Mode Line	Compliance	G.651.1 OFNR fiber
	Max Reach over OM3 MM Fiber	3km (1.8 miles)
Single-Mode Line	Compliance	G.652D OFNR fiber
	Max Reach over OS1 SM Fiber	33km (20.5 miles)
Extended RS-232	Baud Rate	300 to 115200
User Interface	Indicators	Optical link LEDs
Power	Consumption	9W
Environmental Conditions	Operating Temperature	0° to +40°C (32° to 104°F)
	Storage Temperature	-40° to +70°C (-40° to 158°F)
	Humidity	10% to 90%, RHL non-condensing
Regulatory Compliance	Safety	CE, UL
	Environmental	RoHs, WEEE
Included Accessories	2 MM SFP+ transceivers	

VGAA-IN2-F34 / VGAA-OUT2-F34

- **VGAA-IN2-F34:** 2 15-pin HD connectors with 2 analog audio ports.
- **VGAA-OUT2-F34:** 2 15-pin HD connectors with 2 analog audio ports.

Ports	2 VGA	On 15-pin HD connectors
	2 Unbalanced Analog Audio	On 3.5mm mini jack connectors (accessible via C GF/GMAF-30 cables)
Bandwidth	450MHz	
Maximum Range	10m (32ft)	
Power	Consumption	9.5W
Environmental Conditions	Operating Temperature	0° to +40°C (32° to 104°F)
	Storage Temperature	-40° to +70°C (-40° to 158°F)
	Humidity	10% to 90%, RHL non-condensing
Regulatory Compliance	Safety	CE
	Environmental	RoHs, WEEE
Included Accessories	2 MM SFP+ transceivers	
Product	Net Dimensions (W, D, H)	13cm x 25cm x 2cm (5.2" x 10" x 1")
	Net weight	0.3kg (0.7lbs) approx.
Shipping	Dimensions (W, D, H)	16.50cm x 34.50cm x 5.90cm (6.50" x 13.58" x 2.32")
	Weight	0.7kg (1.4lbs) approx.

SDIA-IN2-F34

- 2 BNC connectors with 2 analog audio ports.

Ports	2 SDI 75Ω	On BNC connectors.
	2 Unbalanced Analog Audio	On 3.5mm mini jack connectors.
Total Bandwidth		3Gps
Maximum Range	SD	300m (980ft)
	HD 1080p	200m (655ft)
	3G 1080p	90m (295ft)
3D Pass Through		Not supported
Power	Consumption	6W
Environmental Conditions	Operating Temperature	0° to +40°C (32° to 104°F)
	Storage Temperature	-40° to +70°C (-40° to 158°F)
	Humidity	10% to 90%, RHL non-condensing
Regulatory Compliance	Safety	CE
	Environmental	RoHs, WEEE
Product	Net Dimensions (W, D, H)	13cm x 25cm x 2cm (5.2" x 10" x 1")
	Net weight	0.3kg (0.7lbs) approx.
Shipping	Dimensions (W, D, H)	16.50cm x 34.50cm x 5.90cm (6.50" x 13.58" x 2.32")
	Weight	0.5kg (1.0lbs) approx.

MC3-2S-2S

- **MC3-2S-2S:** 2 SDI inputs and 2 SDI outputs.

Inputs	2 12G SDI	On 75Ω BNC female connectors
Outputs	2 12G SDI	On 75Ω BNC female connectors
SDI	Data Rate	270Mbps to 12Gbps
	Max Output Level	800mVpp / 75Ω
	Cable Equalization Reach	800mVpp / 75Ω
Video	Max SDI Resolution	4K60 4:2:2
	Scaling Input Resolution	NTSC, PAL, 720p, 1080i, 1080p and 2160p
	Max Switching Time Between Inputs	1.5 seconds
	Output Transition on Switching	Smooth cut-thru
	Video Latency	1-2 frames
	Standards Compliance	SMPTE 259M (SD-SDI), 292M (HD-SDI), 424M (3G HD-SDI), ST-2081 (6G-SDI), ST-2082 (12G-SDI)
Cable Equalization Reach	12Gbps	Up to 80m (260ft)
	6Gbps	Up to 100m (330ft)
	3Gbps	Up to 180m (590ft)
	1.5Gbps	Up to 200m (660ft)
	SD	Up to 300m (980ft)
	 When using Kramer cables	
Environmental Conditions	Operating Temperature	0° to +40°C (32° to 104°F)
	Storage Temperature	-40° to +70°C (-40° to 158°F)
	Humidity	10% to 90%, RHL non-condensing
Regulatory Compliance	Safety	CE, FCC, UKCA
	Environmental	RoHs and WEEE
Product	Net Dimensions (W, D, H)	13cm x 25.5cm x 2cm (5.1" x 10" x 0.79")
	Net weight	0.2kg (0.5lbs) approx.

Shipping	Dimensions (W, D, H)	29.5cm x 16.6cm x 6.4cm (11.6" x 6.5" x 2.5")
	Weight	0.4kg (0.9lbs) approx.

MC3-2F-2F

- **MC3-2F-2F:** 2 fiber optic inputs and 2 fiber optic outputs.

Inputs	2 Fiber Optic	On LC female connectors
Outputs	2 Fiber Optic	On LC female connectors
Fiber	Optical Fiber	Multi-mode (MM) or single-mode (SM)
	Optical Module	Kramer 10Gbps SFP+ IEEE 802.3ae compliant modules (MM is included)
	Laser Safety Compliance	Class 1
	SFP Regulatory Certifications	FDA CDRH 21 CFR 1040 and Laser Notice No. 50, UL and CUL EN60950-2:2007, RoHS6, EMC EN 55022 and EN 55024, IEC 62368-1 and IEC 60825-1 and -2
	MM Compliance	G.651.1 OFNR fiber
	Max Reach over OM3 MM Fiber	3km (1.8 miles)
	SM Compliance	G.652D OFNR fiber
	Max Reach over OS1 SM Fiber	33km (20.5 miles)
	 When using Kramer optical modules	
Video	Max Data Rate	18Gbps (6G per channel)
	Max Resolution	4K@60 (4:4:4)
	Max Switching Time Between Inputs	6.5 seconds Note: Assuming typical display with up to 3sec delay time contribution
	Output Transition on Switching	Black/Blue screen
	HDMI Compliance	4K as specified in HDMI 2.0b
	Content Protection	HDCP 2.2
	RS-232 Extension	Baud Rate
Environmental Conditions	Operating Temperature	0° to +40°C (32° to 104°F)
	Storage Temperature	-40° to +70°C (-40° to 158°F)
	Humidity	10% to 90%, RHL non-condensing
Regulatory Compliance	Safety	CE, FCC, UKCA
	Environmental	RoHs and WEEE
Product	Net Dimensions (W, D, H)	13cm x 25.5cm x 2cm (5.1" x 10" x 0.79")
	Net weight	0.2kg (0.5lbs) approx.
Shipping	Dimensions (W, D, H)	29.5cm x 16.6cm x 6.4cm (11.6" x 6.5" x 2.5")
	Weight	0.4kg (0.9lbs) approx.

MC3-2H-2T / MC3-2R-2H

- **MC3-2H-2T:** 2 HDMI inputs and 2 HDBT outputs (transmitters).
- **MC3-2R-2H:** 2 HDBT inputs (receivers) and 2 HDMI outputs.

Inputs	MC3-2H-2T: 2 HDMI	On HDMI connectors	
	MC3-2R-2H: 2 HDBaseT	On RJ-45 connectors	
Outputs	MC3-2H-2T: 2 HDBaseT	On RJ-45 connectors	
	MC3-2R-2H: 2 HDMI	On HDMI connectors	
Extension Line	Reach	Up to 100m (330ft)	
		 When using Kramer HDBaseT cables.	
	Standards Compliance	HDBaseT 3.0	
Video	Max Data Rate	18Gbps (6Gbps per graphic channel)	
	Max. Resolution	4K@60Hz (4:4:4)	
	Resolutions	480i@30Hz, 480p@60/72/75/85Hz, 576p@50Hz, 600p@60/72/75/85Hz, 768p@50/60/70/75/85Hz, 800p@60Hz, 864p@75Hz, 900p@60Hz, 640x480p@60/72/75/85Hz, 720x480i@30Hz, 720x480p@60Hz, 720x576p@50Hz, 800x600p@60/72/75/85Hz, 848x480p@60Hz, 852x480p@60Hz, 1024x768p@60/70/75/85Hz, 1152x864p@75Hz, 1280x768p@60Hz, 1280x800p@60Hz, 1280x960@60Hz, 1280x1024p@60/75Hz, 1360x768p@60Hz, 1366x768p@50/60Hz, 1400x1050p@60Hz, 1440x900p@60Hz, 1600x900p@60Hz, 1600x1200p@60Hz, 1680x1050p@60Hz, 1920x1080i@50/60Hz, 1920x1080p@24/30/50/60Hz, 3840x2160p@24/30/60Hz RB, 4096x2160p@24/30/60Hz, 3840x2160p@24/30/60Hz	
	Max Switching Time Between Inputs	1.5 seconds	
	Output Transition on Switching	Smooth cut-thru	
	Video Latency	1 – 2 frames	
	HDMI Compliance	4K, HDR10 as specified in HDMI 2.0b	
	Content Protection	HDCP 2.3	
	Extended USB	Data Rate	Up to 480Mbps
		Throughput	Up to 12Mbps
Device Type		HID	
Standards Compliance		1.1 and 2.0 USB	
Extended Ethernet	Bandwidth	Up to 1Gbps	
Extended RS-232	Baud Rate	9600 to 115200	
Power	Consumption	21.5W	
Environmental Conditions	Operating Temperature	0° to +40°C (32° to 104°F)	
	Storage Temperature	–40° to +70°C (–40° to 158°F)	
	Humidity	10% to 90%, RHL non-condensing	
Regulatory Compliance	Safety	CE, UKCA	
	Environmental	RoHs and WEEE	
Product	Net Dimensions (W, D, H)	13cm x 25.5cm x 2cm (5.1" x 10" x 0.79")	
	Net weight	0.4kg (0.9lbs) approx.	
Shipping	Dimensions (W, D, H)	29.5cm x 16.6cm x 6.4cm (11.6" x 6.5" x 2.5")	
	Weight	0.5kg (1.1lbs) approx.	

Default Communication Parameters

RS-232 Control / Protocol 3000	
Baud Rate:	115,200
Data Bits:	8
Stop Bits:	1
Parity:	None
Command Format:	ASCII
Protocol 3000 Example: Route Output 3 to Input 1:	#AV 1>3 <CR>
IP	
To reset the IP settings to the factory reset values go to: Menu->Setup -> Factory Reset-> press Enter to confirm	
IP Address:	192.168.1.39
Subnet mask:	255.255.0.0
Default gateway:	192.168.0.1
TCP Port #:	5000
UDP Port #:	50000
Administrator	
Username:	admin
Password:	M01@kramer
Full Factory Reset	
OSD	Go to: Menu-> Setup -> Factory Reset -> press Enter to confirm
Front panel buttons	Press Default Setup (14) and then select 1 to reset the machine

Default EDID

Monitor

Model name..... MTX3-XXX (where XXX are the first 3 letters of the input card model, for example on input card H2A-IN2-F34, the default EDID is MTX3-H2A).

Manufacturer..... KMR

Plug and Play ID..... KMR1200

Serial number..... 295-883450100

Manufacture date..... 2014, ISO week 255

EDID revision..... 1.3

Input signal type..... Digital

Color bit depth..... Undefined

Display type..... Monochrome/grayscale

Screen size..... 520 x 320 mm (24.0 in)

Power management..... Standby, Suspend, Active off/sleep

Extension blocs..... 1 (CEA-EXT)

DDC/CI..... n/a

Color characteristics

Default color space..... Non-sRGB

Display gamma..... 2.20

Red chromaticity..... Rx 0.674 - Ry 0.319

Green chromaticity..... Gx 0.188 - Gy 0.706

Blue chromaticity..... Bx 0.148 - By 0.064

White point (default)... Wx 0.313 - Wy 0.329

Additional descriptors... None

Timing characteristics

Horizontal scan range.... 30-83kHz

Vertical scan range..... 56-76Hz

Video bandwidth..... 170MHz

CVT standard..... Not supported

GTF standard..... Not supported

Additional descriptors... None

Preferred timing..... Yes
 Native/preferred timing.. 1920x1080p at 60Hz (16:9)
 Modeline..... "1920x1080" 148.500 1920 2008 2052 2200 1080 1084 1089 1125 +hsync +vsync

Standard timings supported

720 x 400p at 70Hz - IBM VGA
 720 x 400p at 88Hz - IBM XGA2
 640 x 480p at 60Hz - IBM VGA
 640 x 480p at 67Hz - Apple Mac II
 640 x 480p at 72Hz - VESA
 640 x 480p at 75Hz - VESA
 800 x 600p at 56Hz - VESA
 800 x 600p at 60Hz - VESA
 800 x 600p at 72Hz - VESA
 800 x 600p at 75Hz - VESA
 832 x 624p at 75Hz - Apple Mac II
 1024 x 768i at 87Hz - IBM
 1024 x 768p at 60Hz - VESA
 1024 x 768p at 70Hz - VESA
 1024 x 768p at 75Hz - VESA
 1280 x 1024p at 75Hz - VESA
 1152 x 870p at 75Hz - Apple Mac II
 1280 x 1024p at 75Hz - VESA STD
 1280 x 1024p at 85Hz - VESA STD
 1600 x 1200p at 60Hz - VESA STD
 1024 x 768p at 85Hz - VESA STD
 800 x 600p at 85Hz - VESA STD
 640 x 480p at 85Hz - VESA STD
 1152 x 864p at 70Hz - VESA STD
 1280 x 960p at 60Hz - VESA STD

EIA/CEA-861 Information

Revision number..... 3
 DTV underscan..... Supported
 Basic audio..... Supported
 YCbCr 4:4:4..... Not supported
 YCbCr 4:2:2..... Not supported
 Native formats..... 1
 Detailed timing #1..... 1920x1080p at 60Hz (16:10)
 Modeline..... "1920x1080" 148.500 1920 2008 2052 2200 1080 1084 1089 1125 +hsync +vsync
 Detailed timing #2..... 1920x1080i at 60Hz (16:10)
 Modeline..... "1920x1080" 74.250 1920 2008 2052 2200 1080 1084 1094 1124 interlace +hsync +vsync
 Detailed timing #3..... 1280x720p at 60Hz (16:10)
 Modeline..... "1280x720" 74.250 1280 1390 1430 1650 720 725 730 750 +hsync +vsync
 Detailed timing #4..... 720x480p at 60Hz (16:10)
 Modeline..... "720x480" 27.000 720 736 798 858 480 489 495 525 -hsync -vsync

CE audio data (formats supported)

LPCM 2-channel, 16/20/24 bit depths at 32/44/48 kHz

CE video data (timings supported)

1920 x 1080p at 60Hz - HDTV (16:9, 1:1) [Native]
 1920 x 1080i at 60Hz - HDTV (16:9, 1:1)
 1280 x 720p at 60Hz - HDTV (16:9, 1:1)
 720 x 480p at 60Hz - EDTV (16:9, 32:27)
 720 x 480p at 60Hz - EDTV (4:3, 8:9)
 720 x 480i at 60Hz - Doublescan (16:9, 32:27)
 720 x 576i at 50Hz - Doublescan (16:9, 64:45)
 640 x 480p at 60Hz - Default (4:3, 1:1)
 NB: NTSC refresh rate = (Hz*1000)/1001

CE vendor specific data (VSDB)

IEEE registration number. 0x000C03
 CEC physical address..... 0.1.0.0
 Maximum TMDS clock..... 165MHz

CE speaker allocation data

Channel configuration.... 2.0
 Front left/right..... Yes
 Front LFE..... No
 Front center..... No
 Rear left/right..... No
 Rear center..... No
 Front left/right center.. No
 Rear left/right center... No
 Rear LFE..... No

Report information

Date generated..... 2022/9/15
 Software revision..... 2.41.0.818
 Operating system..... 6.1.7601.2.Service Pack 1

Protocol 3000

Kramer devices can be operated using Kramer Protocol 3000 commands sent via serial or Ethernet ports.

Understanding Protocol 3000

Protocol 3000 commands are a sequence of ASCII letters, structured according to the following.

- **Command format:**

Prefix	Command Name	Constant (Space)	Parameter(s)	Suffix
#	Command	_	Parameter	<CR>

- **Feedback format:**

Prefix	Device ID	Constant	Command Name	Parameter(s)	Suffix
~	nn	@	Command	Parameter	<CR><LF>

- **Command parameters** – Multiple parameters must be separated by a comma (.). In addition, multiple parameters can be grouped as a single parameter using brackets ([and]).
- **Parameters attributes** – Parameters may contain multiple attributes. Attributes are indicated with pointy brackets (<...>) and must be separated by a period (.).

The command framing varies according to how you interface with **MTX3-16-M/MTX3-34-M**. The following figure displays how the # command is framed using terminal communication software (such as Hercules):

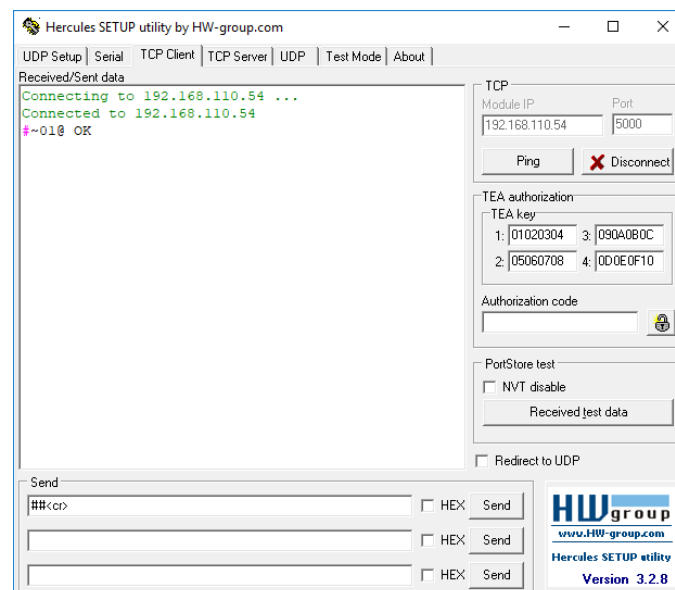



Protocol 3000 Commands



The commands are identical for all the modular matrices, except for the number of ports.

Function	Description	Syntax	Parameters/Attributes	Example
#	<p>Protocol handshaking.</p> <p>① Validates the Protocol 3000 connection and gets the machine number.</p> <p>Step-in master products use this command to identify the availability of a device.</p>	<p>COMMAND</p> <p>#<CR></p> <p>FEEDBACK</p> <p>~nn@_ok<CR><LF></p>		#<CR>
AUD	<p>LEGACY COMMAND.</p> <p>Switch Audio Matrix.</p> <p>① When AFV switching mode is active, this command also switches video and unit replies with command ~AV.</p>	<p>COMMAND</p> <p>#AUD_in>out_id,in>out_id,...<CR></p> <p>FEEDBACK</p> <p>~nn@AUD_in>out_id<CR><LF></p> <p>~nn@AUD_in>out_id<CR><LF></p>	<p>in – Input number or '0' to disconnect output</p> <p>> – Connection character between in and out parameters</p> <p>out_id – Output number</p> <p>* for all outputs</p>	<p>Switch embedded audio HDMI IN 1 to HDMI OUT 3:</p> <p>#AUD_1>3<CR></p>
AUD?	<p>LEGACY COMMAND.</p> <p>Get audio switch state.</p> <p>① When AFV switching mode is active, this command also switches video and unit replies with command ~AV.</p>	<p>COMMAND</p> <p>#AUD?_out_id<CR></p> <p>#AUD?_*<CR></p> <p>FEEDBACK</p> <p>~nn@AUD_in>out_id<CR><LF></p> <p>~nn@AUD_in>1,in>2,...<CR><LF></p>	<p>in – Input number or '0' to disconnect output</p> <p>> – Connection character between in and out parameters</p> <p>out_id – Output number</p> <p>* for all outputs</p>	<p>Get audio switch state for output 1:</p> <p>#AUD?_1<CR></p>
AUD-LVL	Set volume level.	<p>COMMAND</p> <p>#AUD-LVL_io_mode,io_index,vol_level<CR></p> <p>FEEDBACK</p> <p>~nn@AUD-LVL_io_mode,io_index,vol_level<CR><LF></p>	<p>io_mode - 0 for input port, 1 for output port</p> <p>io_index - port number (1-16)</p> <p>vol_level - volume level, 0 to 70.</p>	<p>Set audio level of output 1 to 20:</p> <p>#AUD_1,1,20<CR></p>
AUD-LVL?	Get volume level.	<p>COMMAND</p> <p>#AUD-LVL?_io_mode,io_index<CR></p> <p>FEEDBACK</p> <p>~nn@AUD-LVL_io_mode,io_index,vol_level<CR><LF></p>	<p>io_mode - 0 for input port, 1 for output port</p> <p>io_index - port number (1-16)</p> <p>vol_level - volume level, 0 to 70.</p>	<p>Set audio level of output 1 to 20:</p> <p>#AUD_1,1?<CR></p>
AV	Switch audio and video matrix at the same time.	<p>COMMAND</p> <p>#AV_in>out_id,in>out_id,...<CR></p> <p>FEEDBACK</p> <p>~nn@AV_in>out_id,in>out_id,...<CR><LF></p>	<p>in – Number that indicates the specific input:</p> <p>1-16</p> <p>0 - disconnect output</p> <p>> – Connection character between in and out parameters</p> <p>out_id – Output number</p> <p>* for all outputs</p>	<p>Switch IN 1 to OUT 4:</p> <p>#AV_1>4<CR></p>
BALANCE	Set balance level.	<p>COMMAND</p> <p>#BALANCE_out_index,balance_level<CR></p> <p>FEEDBACK</p> <p>~nn@BALANCE_out_index,balance_level<CR><LF></p>	<p>out_index – Number of the output/input port: 1-16</p> <p>balance_level – Audio parameter in the module card, 0 – 100, ++, --.</p>	<p>Set the speaker output balance to +12:</p> <p>#BALANCE_1,12<CR></p>
BALANCE?	Get balance level.	<p>COMMAND</p> <p>#BALANCE?_out_index<CR></p> <p>FEEDBACK</p> <p>~nn@BALANCE_out_index,balance_level<CR><LF></p>	<p>out_index – Number of the output/input port: 1-16</p> <p>balance_level – Audio parameter in the module card, 0 – 100, ++, --.</p>	<p>Get balance level for channel 1:</p> <p>#BALANCE?_1<CR></p>
BASS	Set audio bass level.	<p>COMMAND</p> <p>#BASS_io_index,bass_level<CR></p> <p>FEEDBACK</p> <p>~nn@BASS_io_index,bass_level<CR><LF></p>	<p>out_index – Number of the output/input port: 1-16</p> <p>balance_level – Audio parameter in the module card, 0 – 100, ++, --.</p>	<p>Set audio bass level of channel 1 to 5:</p> <p>#BASS_1,5<CR></p>
BASS?	Get audio bass level.	<p>COMMAND</p> <p>#BASS?_io_index<CR></p> <p>FEEDBACK</p> <p>~nn@BASS_io_index,bass_level<CR><LF></p>	<p>out_index – Number of the output/input port: 1-16</p> <p>balance_level – Audio parameter in the module card, 0 – 100, ++, --.</p>	<p>Get audio bass level of channel 1:</p> <p>#BASS?_1<CR></p>
BAUD	<p>Set protocol serial port baud rate.</p> <p>① The new defined baud rate is stored in the EEPROM and used when powering up.</p> <p>Default baud rate is 115200 (on factory reset).</p> <p>Only works with devices supporting this command (if ERR 002 is returned, the default baud rate is used).</p>	<p>COMMAND</p> <p>#BAUD_baud_rate<CR></p> <p>FEEDBACK</p> <p>~nn@BAUD_baud_rate<CR><LF></p> <p>~nn@BAUD_current_baud_rate<CR><LF></p>	<p>baud_rate – One of 9600 / 19200 / 38400 / 57600 / 115200.</p> <p>current_baud_rate – Current protocol serial port baud rate.</p>	<p>Set the baud rate to 9600:</p> <p>#BAUD_9600<CR></p>

Function	Description	Syntax	Parameters/Attributes	Example
BAUD?	<p>Get protocol serial port baud rate.</p> <p> The new defined baud rate is stored in the EEPROM and used when powering up.</p> <p>Default baud rate is 115200 (on factory reset).</p> <p>Only works with devices supporting this command (if ERR 002 is returned, the default baud rate is used).</p>	<p>COMMAND #BAUD?_<CR></p> <p>FEEDBACK ~nn@BAUD_baud_rate<CR><LF> ~nn@BAUD_current_baud_rate<CR><LF></p>	<p>baud_rate – One of 9600 / 19200 / 38400 / 57600 / 115200. current_baud_rate – Current protocol serial port baud rate.</p>	<p>Get protocol serial port baud rate: #BAUD?_<CR></p>
BRIGHTNESS	<p>Set image brightness per output.</p> <p> Value limits can vary for different devices.</p> <p>Value is a property of input connected to current output. Changing input source might cause changes in this value (refer device definitions).</p> <p>In devices that enable showing multiple outputs on one display – each in a separate window – this command relates only to the window associated with the output indicated in the out-index parameter.</p>	<p>COMMAND #BRIGHTNESS_out_index,value<CR></p> <p>FEEDBACK ~nn@BRIGHTNESS_out_index,value<CR><LF></p>	<p>out_index – Number that indicates the specific output: 1-16 value – Brightness value, 1 – 63.</p>	<p>Set brightness for output 1 to 50: #BRIGHTNESS_1,50<CR></p>
BRIGHTNESS?	<p>Get image brightness per output.</p> <p> Value limits can vary for different devices.</p> <p>Value is a property of input connected to current output. Changing input source might cause changes in this value (refer device definitions).</p> <p>In devices that enable showing multiple outputs on one display – each in a separate window – this command relates only to the window associated with the output indicated in the out-index parameter.</p>	<p>COMMAND #BRIGHTNESS?_out_index<CR></p> <p>FEEDBACK ~nn@BRIGHTNESS_out_index,value<CR><LF></p>	<p>out_index – Number that indicates the specific output: 1-16 value – Brightness value, 1 – 63.</p>	<p>Get brightness for output 1: #BRIGHTNESS?_1<CR></p>
BUILD-DATE?	<p>Get device build date.</p>	<p>COMMAND #BUILD-DATE?_<CR></p> <p>FEEDBACK ~nn@BUILD-DATE_date,time<CR><LF></p>	<p>date – Format: YYYY/MM/DD where YYYY = Year MM = Month DD = Day time – Format: hh:mm:ss where hh = hours mm = minutes ss = seconds</p>	<p>Get the device build date: #BUILD-DATE?<CR></p>

Function	Description	Syntax	Parameters/Attributes	Example
CONTRAST	<p>Set image contrast per output.</p> <p>ⓘ Value limits can vary for different devices.</p> <p>Value is a property of input connected to current output. Changing the input source might cause changes in this value (refer to device definitions).</p> <p>In devices that enable showing multiple outputs on one display – each in a separate window – this command relates only to the window associated with the output indicated in the out-index parameter.</p>	<p>COMMAND</p> <pre>#CONTRAST_<out_index>,value<CR></pre> <p>FEEDBACK</p> <pre>~nn@CONTRAST_<out_index>,value<CR><LF></pre>	<p>out_index – Number that indicates the specific output: 1-16</p> <p>value –, Contrast value 1 – 63.</p>	<p>Set contrast for output 1 to 40:</p> <pre>#CONTRAST_1,40<CR></pre>
CONTRAST?	<p>Get image contrast per output.</p> <p>ⓘ Value limits can vary for different devices.</p> <p>Value is a property of input connected to current window. Changing the window input source might cause changes in this value (refer to device definitions).</p> <p>In devices that enable showing multiple outputs on one display – each in a separate window – this command relates only to the window associated with the output indicated in the out-index parameter.</p>	<p>COMMAND</p> <pre>#CONTRAST?_<out_index><CR></pre> <p>FEEDBACK</p> <pre>~nn@CONTRAST_<out_index>,value<CR><LF></pre>	<p>out_index – Number that indicates the specific output: 1-16</p> <p>value – Contrast value, 1- 63.</p>	<p>Get contrast for output 1:</p> <pre>#CONTRAST?_1<CR></pre>
CPEDID	<p>Copy EDID data from the output to the input EEPROM.</p> <p>ⓘ Destination bitmap size depends on device properties (for 64 inputs it is a 64-bit word).</p> <p>Example: bitmap 0x0013 means inputs 1,2 and 5 are loaded with the new EDID.</p> <p>In certain products Safe_mode is an optional parameter. See the HELP command for its availability.</p>	<p>COMMAND</p> <pre>#CPEDID_<edid_io>,src_id,<edid_io>,dest_bitmap<CR></pre> <p>or</p> <pre>#CPEDID_<edid_io>,src_id,<edid_io>,dest_bitmap,<safe_mode><CR></pre> <p>FEEDBACK</p> <pre>~nn@CPEDID_<edid_io>,src_id,<edid_io>,dest_bitmap<CR><LF></pre> <pre>~nn@CPEDID_<edid_io>,src_id,<edid_io>,dest_bitmap,<safe_mode><CR><LF></pre>	<p>edid_io – EDID source type (usually output)</p> <ul style="list-style-type: none"> 0 – Input 1 – Output 2 – Default EDID <p>src_id – Number of chosen source port</p> <ul style="list-style-type: none"> 0 – Default EDID source, 1 – 16: Port number. <p>edid_io – EDID destination type</p> <ul style="list-style-type: none"> 0 – Input <p>dest_bitmap – Bitmap representing destination IDs. Format: XXXX...X, where X is hex digit. The binary form of every hex digit represents corresponding destinations.</p> <ul style="list-style-type: none"> 0 – indicates that EDID data is not copied to this destination. 1 – indicates that EDID data is copied to this destination. <p>safe_mode – Safe mode</p> <ul style="list-style-type: none"> 0 – device accepts the EDID as is without trying to adjust 1 – device tries to adjust the EDID (default value if no parameter is sent) 	<p>Copy the EDID data from the Output 1 (EDID source) to the Input:</p> <pre>#CPEDID_1,1,0,0x1<CR></pre> <p>Copy the EDID data from the default EDID source to the Input:</p> <pre>#CPEDID_2,0,0,0x1<CR></pre>
DETAIL-TIMING?	<p>Get detail timing parameters.</p>	<p>COMMAND</p> <pre>#DETAIL-TIMING?_<param>,in_index<CR></pre> <p>FEEDBACK</p> <pre>~nn@DETAIL-TIMING_<param>,in_index,value<CR><LF></pre>	<p>param – Detail Timing</p> <ul style="list-style-type: none"> 2 – H-active 5 – V-active <p>in_index – Number of the port: 1-16</p> <p>value – Video parameter in Kramer units, minus sign precedes negative values.</p>	<p>Get detail timing parameters:</p> <pre>#@DETAIL-TIMING?_2,1<CR></pre>
DISPLAY?	<p>Get output HPD status.</p>	<p>COMMAND</p> <pre>#DISPLAY?_<out_index><CR></pre> <p>FEEDBACK</p> <pre>~nn@DISPLAY_<out_index>,status<CR><LF></pre>	<p>out_index – Number of the output port: 1-16</p> <p>status – HPD status according to signal validation</p> <ul style="list-style-type: none"> 0 – Sink is not valid 1 – Sink is valid 2 – Sink and EDID are valid 	<p>Get the output HPD status of port 1:</p> <pre>#DISPLAY?_1<CR></pre>

Function	Description	Syntax	Parameters/Attributes	Example
EQ-LVL	Set equalization level.	COMMAND #EQ-LVL _{io_mode,io_index,eq_type,eq_level} <CR> FEEDBACK ~nn@EQ-LVL _{io_mode,io_index,eq_type,eq_level} <CR><LF>	io_mode – Input/Output 0 – Input 1 – Output io_index – Number that indicates the specific input or output port: 1-16 eq_type – Equalizer Types 0 – Bass 1 – Treble eq_level – Equalizer level (range 0 – 15).	Set Bass EQ level of the speaker output to 12: #EQ-LVL _{1,1,0,12} <CR>
EQ-LVL?	Get equalization level.	COMMAND #EQ-LVL? _{io_mode,io_index,eq_type} <CR> FEEDBACK ~nn@EQ-LVL _{io_mode,io_index,eq_type,eq_level} <CR><LF>	io_mode – Input/Output 0 – Input 1 – Output io_index – Number that indicates the specific input or output port: 1-16 eq_type – Equalizer Types 0 – Bass 1 – Treble eq_level – Equalizer level (range 0 – 15).	Get Bass EQ level of the speaker output 2 to 12: #EQ-LVL?_1,2,0<CR>
ETH-PORT	Set Ethernet port protocol. ⓘ If the port number you enter is already in use, an error is returned. The port number must be within the following range: 0-(2 ¹⁶ -1).	COMMAND #ETH-PORT _{port_type,port_id} <CR> FEEDBACK ~nn@ETH-PORT _{port_type,port_id} <CR><LF>	port_type – TCP/UDP port_id – TCP/UDP port number (0 – 65535)	Set the Ethernet port protocol for TCP to port 12457: #ETH-PORT _{0,12457} <CR>
ETH-PORT?	Get Ethernet port protocol.	COMMAND #ETH-PORT? _{port_type} <CR> FEEDBACK ~nn@ETH-PORT _{port_type,port_id} <CR><LF>	port_type – TCP/UDP 0 – TCP 1 – UDP port_id – TCP / UDP port number (0 – 65535)	Get the Ethernet port protocol for UDP: #ETH-PORT?_1<CR>
EXT-DEF-VIDIN	Set the default input for an output. ⓘ This command defines the default routing for the first time an output module card is installed into a slot. ⓘ This setting is not deleted after factory reset.	COMMAND #EXT-DEF-VIDIN _{out_index,in_index} <CR> FEEDBACK ~nn@EXT-DEF-VIDIN _{out_index,in_index} <CR><LF>	out_index – Number that indicates the specific output: 1-16 * – All outputs in_index – Number that indicates the specific input: 1-16	Set input 1 as the default for output 3: #EXT-DEF-VIDIN _{3,1} <CR>
EXT-DEF-VIDIN?	Set the default input for an output.	COMMAND #EXT-DEF-VIDIN? _{out_index} <CR> FEEDBACK ~nn@EXT-DEF-VIDIN? _{out_index,in_index} <CR><LF>	out_index – Number that indicates the specific output: 1-16 * – All outputs in_index – Number that indicates the specific input: 1-16	Get the default input for output 3: #EXT-DEF-VIDIN?_3<CR>
EXT-FAN-LEVEL	Set the fan level. ⓘ Sets the auto sync features for the selected scaler.	COMMAND #EXT-FAN-LEVEL _{fan_index,fan_speed,fan_mode} <CR> FEEDBACK ~nn@EXT-FAN-LEVEL _{fan_index,fan_speed,fan_mode,fan_status} <CR><LF>	fan_index – Number of the fan being set: 1 – 3. fan_speed : 1 – 7. fan_mode – 0 – Fan operation automatically controlled based on the device temperature 1 – Continuous operation ⓘ The default is automatic. If a fan is set to continuous and the device is reset, the fan returns to automatic. fan_status – OK or WARN.	Set fan #1 speed to 2 and mode to continuous: #EXT-FAN-LEVEL _{1,2,1} <CR>
EXT-FAN-LEVEL?	Get the fan level. ⓘ Sets the auto sync features for the selected scaler.	COMMAND #EXT-FAN-LEVEL? _{fan_index,fan_speed} <CR> FEEDBACK ~nn@EXT-FAN-LEVEL _{fan_index,fan_speed,fan_mode,fan_status} <CR><LF>	fan_index – Number of the fan being set: 1 – 3. fan_speed : 1 – 7. fan_mode – 0 – Fan operation automatically controlled based on the device temperature 1 – Continuous operation ⓘ The default is automatic. If a fan is set to continuous and the device is reset, the fan returns to automatic. fan_status – OK or WARN.	Get fan #1 status: #EXT-FAN-LEVEL?_1<CR>
EXT-INFO-IO?	Get a list of ports according to signal type (video or audio) and direction (inputs or outputs).	COMMAND #EXT-INFO-IO? _{signal_type,io_mode} <CR> FEEDBACK ~nn@Device _{signal_type,io_mode,io_index,io_index,io_index,...} <CR><LF>	signal_type – 1 – video 2 – audio io_mode – Input/Output 0 – Input 1 – Output io_index – Number that indicates the specific input or output port: 1-16	Get the list of video input ports: #EXT-INFO-IO?_1,0<CR>

Function	Description	Syntax	Parameters/Attributes	Example
FACTORY	<p>Reset device to factory default configuration.</p> <p>i This command restores all system parameters except MAC address, MODEL, SN and account settings.</p> <p>All user data is deleted from the device. The deletion can take some time.</p> <p>Device requires powering off and powering on for the changes to take effect.</p> <p>User accounts and passwords will be removed, leaving the admin account and the default password.</p>	COMMAND #FACTORY<CR> FEEDBACK ~nn@FACTORY_ok<CR><LF>		Reset the device to factory default configuration: #FACTORY<CR>
FPGA-VER?	<p>Get current FPGA version.</p>	COMMAND #FPGA-VER?_ufpga_id<CR> FEEDBACK ~nn@FPGA-VER_ufpga_id,expected_ver,ver<CR><LF>	fpga_id – FPGA id (default is 0). expected_ver – Expected FPGA version for current firmware ver – Actual FPGA version	Get current FPGA version: #FPGA-VER?_u1<CR>
GEDID	<p>Get EDID support on certain input/output.</p> <p>i For old devices that do not support this command, ~nn@ERR 002<CR><LF> is received.</p>	COMMAND #GEDID_io_mode,in_index<CR> FEEDBACK ~nn@GEDID_io_mode,in_index,size<CR><LF>	io_mode – Input/Output 0 – Input 1 – Output 2 – Default EDID in_index – Number that indicates the specific input: 1-16 size – Size of data to be sent from device, 0 means no EDID support	Get EDID support information for input 1: #GEDID_u,0,1#<CR>
H-PHASE	<p>Set H-phase.</p>	COMMAND #H-PHASE_io_mode,io_index,value<CR> FEEDBACK ~nn@H-PHASE_io_mode io_index value<CR><LF>	io_mode – Input/Output 1 – Input 2 – Output io_index – Number that indicates the specific input or output port: 1–16 value – Video parameter in Kramer units: 0–63 ++ increase current value – decrease current value	Set H-phase on input port 1 to 1: #H-PHASE_1,1,1<CR>
H-PHASE?	<p>Get H-phase.</p>	COMMAND #H-PHASE?_io_mode,io_index<CR> FEEDBACK ~nn@H-PHASE_io_mode io_index value<CR><LF>	io_mode – Input/Output 1 – Input 2 – Output io_index – Number that indicates the specific input or output port: 1–16 value – Video parameter in Kramer units, minus sign precedes negative values	Get H-phase for input port 1: #H-PHASE?_u,1,1<CR>
HDCP-MOD	<p>Set HDCP mode.</p> <p>i Set HDCP working mode on the device input:</p> <p>HDCP supported - HDCP_ON [default].</p> <p>HDCP not supported - HDCP OFF.</p> <p>HDCP support changes following detected sink - MIRROR OUTPUT.</p> <p>When you define 3 as the mode, the HDCP status is defined according to the connected output in the following priority: OUT 1, OUT 2. If the connected display on OUT 2 supports HDCP, but OUT 1 does not, then HDCP is defined as not supported. If OUT 1 is not connected, then HDCP is defined by OUT 2.</p>	COMMAND #HDCP-MOD_in_index,mode<CR> FEEDBACK ~nn@HDCP-MOD_in_index,mode<CR><LF>	in_index – Number that indicates the specific input: 1-N (N= the total number of inputs) mode – HDCP mode: 0 – HDCP Off 1 – HDCP On	Set the input HDCP-MODE of IN 1 to Off: #HDCP-MOD_u,1,0<CR>

Function	Description	Syntax	Parameters/Attributes	Example												
HDCP-MOD?	Get HDCP mode. ① Set HDCP working mode on the device input: HDCP supported - HDCP_ON [default]. HDCP not supported - HDCP OFF. HDCP support changes following detected sink - MIRROR OUTPUT.	COMMAND #HDCP-MOD?_in_index<CR> FEEDBACK ~nn@HDCP-MOD_in_index,mode<CR><LF>	in_index – Number that indicates the specific input: 1-16 mode – HDCP mode: 0 – HDCP Off 1 – HDCP On	Get the input HDCP-MODE of IN 1 HDMI: #HDCP-MOD?_1<CR>												
HDCP-STAT?	Get HDCP signal status. ① io_mode =1 – get the HDCP signal status of the sink device connected to the specified output. io_mode =0 – get the HDCP signal status of the source device connected to the specified input.	COMMAND #HDCP-STAT?_io_mode,in_index<CR> FEEDBACK ~nn@HDCP-STAT_io_mode,in_index,status<CR><LF>	io_mode – Input/Output 0 – Input 1 – Output io_index – Number that indicates the specific number of inputs or outputs (based on io_mode): 1-N (N=total number of inputs or outputs) status – Signal encryption status - valid values On/Off 0 – HDCP Off 1 – HDCP On	Get the output HDCP-STATUS of IN 1: #HDCP-STAT?_0,1<CR>												
HELP	Get command list or help for specific command.	COMMAND #HELP<CR> #HELP_cmd_name<CR> FEEDBACK To get help for command use: HELP (COMMAND_NAME)<CR><LF> ~nn@HELP_cmd_name:<CR><LF> description<CR><LF> USAGE: usage<CR><LF>	cmd_name – Name of a specific command	Get the command list: #HELP<CR> To get help for HW-TEMP?: HELP_hw-temp?<CR>												
HW-TEMP?	Get temperature of a specific region of the hardware. ① There is no "Set" command. The Get command is not available for all parts of the hardware, and is device specific.	COMMAND #HW-TEMP?_region_id<CR> FEEDBACK ~nn@HW-TEMP_region_id,temperature<CR><LF>	region_id – ID of the temperature source: 0 - Linux control board. 1 – 8 – Module card in MTX3-34-M 205 – Fan control board * - Status of the Matrix. temperature – Temperature in Celsius of the HW region, rounded down to the closest integer	Get temperature of a specific region of the hardware: #HW-TEMP?_1<CR>												
INFO-IO?	LEGACY COMMAND. Get in/out count.	COMMAND #INFO-IO?_<CR> FEEDBACK ~nn@INFO-IO_IN_in_count,OUT_out_count<CR><LF>	in_count – Number of inputs in the unit out_count – Number of outputs in the unit	Get inputs count: #INFO-IO?_<CR>												
INFO-PRST?	LEGACY COMMAND. Get maximum preset count. ① In most units, video and audio presets with the same number are stored and recalled together by commands #PRST-STO and #PRST-RCL.	COMMAND #INFO-PRST?_<CR> FEEDBACK ~nn@INFO-PRST_vid_video_preset_count,audio_preset_count<CR><LF>	video_preset_count – (1-60) Maximum number of video presets in the unit audio_preset_count – (1-60) Maximum number of audio presets in the unit	Get number of video and audio presets: #INFO-PRST?_<CR>												
LOAD	Load file to device.	COMMAND #LOAD_file_name,size<CR> FEEDBACK Data sending negotiation: * Device - ~01@LOAD_file_name,size_ready<CR><LF> * End User (+Device)- Send file in Protocol Packets * Device - ~01@LOAD_file_name,size_ok<CR><LF>	file_name – Name of file to save on device size – Size of file data that is sent Using the Packet Protocol Send a command: LDRV, LOAD, IROUT, LDEDID Receive Ready or ERR### If Ready: a. Send a packet, b. Receive OK on the last packet, c. Receive OK for the command Packet structure: Packet ID (1, 2, 3...) (2 bytes in length) Length (data length + 2 for CRC) – (2 bytes in length) Data (data length -2 bytes) CRC – 2 bytes <table border="1" data-bbox="943 1848 1230 1883"> <tr> <td>01</td> <td>02</td> <td>03</td> <td>04</td> <td>05</td> <td></td> </tr> <tr> <td>Packet ID</td> <td>Length</td> <td>Data</td> <td>CRC</td> <td></td> <td></td> </tr> </table> 5. Response: ~nnnn_ok<CR><LF> (Where NNNN is the received packet ID in ASCII hex digits.)	01	02	03	04	05		Packet ID	Length	Data	CRC			Load the file_response.dat file to the device: #LOAD_file_response.dat,5360<CR>
01	02	03	04	05												
Packet ID	Length	Data	CRC													
LOCK-FP	Lock the front panel. ① In NT-52N, this command includes the PortNumber (1-2) parameter.	COMMAND #LOCK-FP_lock/unlock<CR> FEEDBACK ~nn@LOCK-FP_lock/unlock<CR><LF>	lock/unlock – On/Off 0 – Off unlocks front panel buttons or keyboard 1 – On locks front panel buttons or keyboard	Unlock front panel: #LOCK-FP_0<CR>												

Function	Description	Syntax	Parameters/Attributes	Example
LOCK-FP?	Get the front panel lock state. ① In NT-52N, this command includes the PortNumber (1-2) parameter.	COMMAND #LOCK-FP?_u<CR> FEEDBACK ~nn@LOCK-FP_u_lock/unlock<CR><LF>	lock/unlock – On/Off 0 – Off unlocks front panel buttons or keyboard 1 – On locks front panel buttons or keyboard	Get the front panel lock state: #LOCK-FP?<CR>
LOG-TAIL?	Get the last “n” lines of message logs. ① Used for advanced troubleshooting. Helps find error root causes and gets details not displayed in the error code number.	COMMAND #LOG-TAIL?_line_num<CR> FEEDBACK Get: ~nn@LOG-TAILnn<CR><LF> Line content #1 <CR><LF> Line content #2 <CR><LF> Etc...	line_num – Optional, default <i>line_num</i> is 10	Get the last “2” lines of message logs: #LOG-TAIL?_2<CR>
MIX	Set audio MIX.	COMMAND #MIX_u_out_index,mix_mode<CR> FEEDBACK ~nn@MIX_u_out_index,mix_mode<CR><LF>	out_index – Number that indicates the specific output: 1-16 mix_mode – On/Off 0 – Off 1 – On	Set audio MIX: #MIX_u,1,1<CR>
MIX?	Get audio MIX.	COMMAND #MIX?_u<CR> FEEDBACK ~nn@MIX_u_out_index,mix_mode<CR><LF>	out_index – Number that indicates the specific output: 1-16 mix_mode – On/Off 0 – Off 1 – On	Get audio MIX: #MIX?_u<CR>
MODEL?	Get device model.	COMMAND #MODEL?_u<CR> FEEDBACK ~nn@MODEL_u_model_name<CR><LF>	model_name – String of up to 19 printable ASCII chars	Get the device model: #MODEL?_u<CR>
MODULE-INFO?	Get module information.	COMMAND #MODULE-INFO?_slot_id<CR> FEEDBACK ~nn@MODULE-INFO_slot_id,m_direction,channel_start,channel_end,mod_type,fw_ver,upgradable,mod_status<CR><LF>	slot_id – Module ID (slot number): 0 – control module 1-x – I/O cards (maximum number dependent on matrix) 201 – keyboard software application 202 – keyboard hardware m_direction – Transmission direction 0 – input 1 – output 2 – unknown channel_start – Start ID of the port in the device - 1-x (maximum number dependent on matrix) channel_end – End ID of the port in the device: 1-x (maximum number dependent on matrix) mod_type – Module type 0 – DVI 1 – HDCP 03 – HDMI 4 – DL 06 – HS 07 – DP 08 – SDI 09 – F610 10 – F670 12 – DGKat 16 – VGA 18 – VGAA 22 – AAD 24 – HAA 25 – HAD 30 – HDBT 32 – SDIA 34 – HDBT7 (VS-1616DN-EM) / DT (VS-3232DN-EM) 41 – UHD 42 – UHDA 45 – DTAxr 47 – control module fw_ver – Module firmware version XX.XX.XXXX where the digit groups are: major.minor.build version upgradable – Indicates whether the firmware can be upgraded 0 – not upgradable 1 – upgradable mod_status – Module status 0 – OK 1 – unknown error 2 – no communication 3 – module missing	Get information for the module in slot 8: #MODULE-INFO?_8<CR>
MODULE-TYPE?	Get module type.	COMMAND #MODULE-TYPE?_module_id<CR> FEEDBACK ~nn@MODULE-TYPE_module_id,mod_type,mod_status<CR><LF>	module_id – Number of the card module, range 1 – 8. mod_status – Module status 0 – OK 1 – Unknown error 2 – No communication 3 – Module missing	Get module type: #MODULE-TYPE?_1<CR>

Function	Description	Syntax	Parameters/Attributes	Example
MODULE-VER?	Get module version. ⓘ Some devices do not set the new machine number until the device is restarted. Some devices can change the machine number only from DIP-switches.	COMMAND #MODULE-VER?_module_id<CR> FEEDBACK ~nn@MODULE-VER?_module_id,fw_version<CR><LF>	module_id – Number that identifies the module 0 – Matrix control board 1–8 – Card module I/O slot number fw_version – XX.XX.XXXX where the digit groups are: major.minor.build version	Get module version: #MODULE-VER?_1<CR>
MUTE	Set audio mute.	COMMAND #MUTE_out_index,mute_mode<CR> FEEDBACK ~nn@MUTE_out_index,mute_mode<CR><LF>	out_index – Number that indicates the specific output: 1-16 mute_mode – On/Off 0 – Off 1 – On	Set Output 1 to mute: #MUTE_1,1<CR>
MUTE?	Get audio mute.	COMMAND #MUTE?_out_index<CR> FEEDBACK ~nn@MUTE_out_index,mute_mode<CR><LF>	out_index – Number that indicates the specific output: 1-16 mute_mode – On/Off 0 – Off 1 – On	Get mute status of output 1 #MUTE_1?<CR>
NAME	Set machine (DNS) name. ⓘ The machine name is not the same as the model name. The machine name is used to identify a specific machine or a network in use (with DNS feature on).	COMMAND #NAME_machine_name<CR> FEEDBACK ~nn@NAME_machine_name<CR><LF>	machine_name – String of up to 15 alpha-numeric chars (can include hyphen, not at the beginning or end)	Set the DNS name of the device to room-442: #NAME_room-442<CR>
NAME?	Get machine (DNS) name. ⓘ The machine name is not the same as the model name. The machine name is used to identify a specific machine or a network in use (with DNS feature on).	COMMAND #NAME?_<CR> FEEDBACK ~nn@NAME_machine_name<CR><LF>	machine_name – String of up to 15 alpha-numeric chars (can include hyphen, not at the beginning or end)	Get the DNS name of the device: #NAME?_<CR>
NAME-RST	Reset machine (DNS) name to factory default. ⓘ Factory default of machine (DNS) name is "KRAMER_" + 4 last digits of device serial number.	COMMAND #NAME-RST<CR> FEEDBACK ~nn@NAME-RST_ok<CR><LF>		Reset the machine name (S/N last digits are 0102): #NAME-RST_kramer_0102<CR>
NET-CONFIG	Set a network configuration. ⓘ Parameters [DNS1] and [DNS2] are optional. ⓘ For Backward compatibility, the id parameter can be omitted. In this case, the Network ID, by default, is 0, which is the Ethernet control port. ⓘ If the gateway address is not compliant to the subnet mask used for the host IP, the command will return an error. Subnet and gateway compliancy specified by RFC950.	COMMAND #NET-CONFIG_netw_id,net_ip,net_mask,gateway,[dns1],[dns2]<CR> FEEDBACK ~nn@NET-CONFIG_netw_id,net_ip,net_mask,gateway<CR><LF>	netw_id – Network ID—the device network interface (if there are more than one). Counting is 0 based, meaning the control port is '0', additional ports are 1,2,3.... net_ip – Network IP net_mask – Network mask gateway – Network gateway	Set the device network parameters to IP address 192.168.113.10, net mask 255.255.0.0, and gateway 192.168.0.1: #NET-CONFIG_0,192.168.113.10,255.255.0.0,192.168.0.1<CR>
NET-CONFIG?	Get a network configuration.	COMMAND #NET-CONFIG?_netw_id<CR> FEEDBACK ~nn@NET-CONFIG_netw_id,net_ip,net_mask,gateway<CR><LF>	netw_id – Network ID—the device network interface (if there are more than one). Counting is 0 based, meaning the control port is '0', additional ports are 1,2,3.... net_ip – Network IP net_mask – Network mask gateway – Network gateway	Get network configuration: #NET-CONFIG?_id<CR>

Function	Description	Syntax	Parameters/Attributes	Example
NET-DHCP	<p>Set DHCP mode.</p> <p>① Only 1 is relevant for the mode value. To disable DHCP, the user must configure a static IP address for the device.</p> <p>Connecting Ethernet to devices with DHCP may take more time in some networks.</p> <p>To connect with a randomly assigned IP by DHCP, specify the device DNS name (if available) using the NAME command. You can also get an assigned IP by direct connection to USB or RS-232 protocol port, if available.</p> <p>For proper settings consult your network administrator.</p> <p>① For Backward compatibility, the id parameter can be omitted. In this case, the Network ID, by default, is 0, which is the Ethernet control port.</p>	<p>COMMAND</p> <pre>#NET-DHCP_idhcp_state<CR></pre> <p>FEEDBACK</p> <pre>~nn@NET-DHCP_idhcp_state<CR><LF></pre>	<p>dhcp_state –</p> <p>1 – Try to use DHCP. (If unavailable, use the IP address set by the factory or the net-ip command).</p>	<p>Enable DHCP mode for port 1, if available:</p> <pre>#NET-DHCP_1<CR></pre>
NET-DHCP?	<p>Get DHCP mode.</p> <p>① For Backward compatibility, the id parameter can be omitted. In this case, the Network ID, by default, is 0, which is the Ethernet control port.</p>	<p>COMMAND</p> <pre>#NET-DHCP?<CR></pre> <p>FEEDBACK</p> <pre>~nn@NET-DHCP_idhcp_mode<CR><LF></pre>	<p>dhcp_mode –</p> <p>0 – Do not use DHCP. Use the IP set by the factory or using the net-ip or net-config command.</p> <p>1 – Try to use DHCP. If unavailable, use the IP set by the factory or using the net-ip or net-config command.</p>	<p>Get DHCP modes for each port:</p> <pre>#NET-DHCP?<CR></pre>
NET-GATE	<p>Set gateway IP.</p> <p>① A network gateway connects the device via another network and maybe over the Internet. Be careful of security issues. For proper settings consult your network administrator.</p>	<p>COMMAND</p> <pre>#NET-GATE_idip_address<CR></pre> <p>FEEDBACK</p> <pre>~nn@NET-GATE_idip_address<CR><LF></pre>	<p>ip_address – Format: xxx.xxx.xxx.xxx</p>	<p>Set the gateway IP address to 192.168.0.1:</p> <pre>#NET-GATE_id192.168.000.001<CR></pre>
NET-GATE?	<p>Get gateway IP.</p> <p>① A network gateway connects the device via another network and maybe over the Internet. Be aware of security problems.</p>	<p>COMMAND</p> <pre>#NET-GATE?_id<CR></pre> <p>FEEDBACK</p> <pre>~nn@NET-GATE_idip_address<CR><LF></pre>	<p>ip_address – Format: xxx.xxx.xxx.xxx</p>	<p>Get the gateway IP address:</p> <pre>#NET-GATE?_id<CR></pre>
NET-IP	<p>Set IP address.</p> <p>① For proper settings consult your network administrator.</p>	<p>COMMAND</p> <pre>#NET-IP_idip_address<CR></pre> <p>FEEDBACK</p> <pre>~nn@NET-IP_idip_address<CR><LF></pre>	<p>ip_address – Format: xxx.xxx.xxx.xxx</p>	<p>Set the IP address to 192.168.1.39:</p> <pre>#NET-IP_id192.168.001.039<CR></pre>
NET-IP?	<p>Get IP address.</p>	<p>COMMAND</p> <pre>#NET-IP?_id<CR></pre> <p>FEEDBACK</p> <pre>~nn@NET-IP_idip_address<CR><LF></pre>	<p>ip_address – Format: xxx.xxx.xxx.xxx</p>	<p>Get the IP address:</p> <pre>#NET-IP?_id<CR></pre>
NET-MAC?	<p>Get MAC address.</p>	<p>COMMAND</p> <pre>#NET-MAC?<CR></pre> <p>FEEDBACK</p> <pre>~nn@NET-MAC_idmac_address<CR><LF></pre>	<p>mac_address – Unique MAC address. Format: XX-XX-XX-XX-XX-XX where X is hex digit</p>	<pre>#NET-MAC?<CR></pre>
NET-MASK	<p>Set subnet mask.</p> <p>① For proper settings consult your network administrator.</p>	<p>COMMAND</p> <pre>#NET-MASK_idnet_mask<CR></pre> <p>FEEDBACK</p> <pre>~nn@NET-MASK_idnet_mask<CR><LF></pre>	<p>net_mask – Format: xxx.xxx.xxx.xxx</p>	<p>Set the subnet mask to 255.255.0.0:</p> <pre>#NET-MASK_id255.255.000.000<CR></pre>
NET-MASK?	<p>Get subnet mask.</p>	<p>COMMAND</p> <pre>#NET-MASK?_id<CR></pre> <p>FEEDBACK</p> <pre>~nn@NET-MASK_idnet_mask<CR><LF></pre>	<p>net_mask – Format: xxx.xxx.xxx.xxx</p>	<p>Get the subnet mask:</p> <pre>#NET-MASK?_id<CR></pre>

Function	Description	Syntax	Parameters/Attributes	Example
PORT-DIRECTION?	<p>Get port direction for video port.</p> <p>i This command defines the direction of a bidirectional port.</p> <p>Then routing is possible between them, use X-ROUTE as following: #X-ROUTE_out.sdi.5,in.sdi.1<CR> ~01#X-ROUTE_out.sdi.5.video.1,in.sdi.1.video.1<CR></p>	COMMAND #PORT-DIRECTION?_port_index<CR> FEEDBACK ~nn@PORT-DIRECTION_port_index,direction<CR><LF>	port_index – Port number from the front panel (1-n) direction – 0 - Input (IN) 1 - Output (OUT)	#PORT-DIRECTION?_5<CR> ~01@PORT-DIRECTION 5,OUT #PORT-DIRECTION?_1<CR> ~01@PORT-DIRECTION 1,IN
PROT-VER?	<p>Get device protocol version.</p>	COMMAND #PROT-VER?_<CR> FEEDBACK ~nn@PROT-VER_3000:version<CR><LF>	version – XX.XX where X is a decimal digit	<p>Get the device protocol version:</p> #PROT-VER?_<CR>
PRST-AUD?	<p>Get audio connections from saved preset.</p> <p>i In most units, video and audio presets with the same number are stored and recalled together by commands #PRST-STO and #PRST-RCL.</p>	COMMAND #PRST-AUD?_preset,>out<CR> #PRST-AUD?_preset,*<CR> FEEDBACK ~@PRST-AUD_preset,>out<CR><LF> ~@PRST-AUD_preset,i>1,i>2,i>3,...<CR><LF>	preset – Preset number: 1-60 0 – Output is disconnected out – Number that indicates the specific output: 1 – 16 * – All outputs > – Connection character between in and out parameters	<p>Get audio input that is connected OUT 3 from preset 1:</p> #PRST-AUD?_1,4<CR>
PRST-LST?	<p>Get saved preset list.</p> <p>i In most units, video and audio presets with the same number are stored and recalled together by commands #PRST-STO and #PRST-RCL.</p>	COMMAND #PRST-LST?_<CR> FEEDBACK ~nn@PRST-LST_preset,preset,...<CR><LF>	preset – Preset number	<p>Show preset list:</p> #PRST-LST?_<CR>
PRST-RCL	<p>Recall saved preset list.</p> <p>i In most units, video and audio presets with the same number are stored and recalled together by commands #PRST-STO and #PRST-RCL.</p>	COMMAND #PRST-RCL_preset<CR> FEEDBACK ~nn@PRST-RCL_preset<CR><LF>	preset – Preset number	<p>Recall preset 1:</p> #PRST-RCL_1<CR>
PRST-STO	<p>Store current connections, volumes and modes in preset.</p> <p>i In most units, video and audio presets with the same number are stored and recalled together by commands #PRST-STO and #PRST-RCL.</p>	COMMAND #PRST-STO_preset<CR> FEEDBACK ~nn@PRST-STO_preset<CR><LF>	preset – Preset number	<p>Store preset 1:</p> #PRST-STO_1<CR>
PRST-VID?	<p>Get video connections from saved preset.</p> <p>i In most units, video and audio presets with the same number are stored and recalled together by commands #PRST-STO and #PRST-RCL.</p>	COMMAND #PRST-VID?_preset,out_id<CR> #PRST-VID?_preset,*<CR> FEEDBACK ~nn@PRST-VID_preset,in_id>out_id<CR><LF> ~nn@PRST-VID_preset,in_id>out_id,in_id>out_id,in_id>out_id<CR><LF>	preset – Preset number – Number of the input: 1 – 16 0 – Output is disconnected > – Connection character between in and out parameters. out_id – Output number, * for all outputs. in_id – Input number, * for all inputs.	<p>Get video connections from preset 3 for all outputs:</p> #PRST-VID?_3,*<CR>

Function	Description	Syntax	Parameters/Attributes	Example
RESET	Reset device. ⓘ To avoid locking the port due to a USB bug in Windows, disconnect USB connections immediately after running this command. If the port was locked, disconnect and reconnect the cable to reopen the port.	COMMAND #RESET<CR> FEEDBACK ~nn@RESET_ok<CR><LF>		Reset the device: #RESET<CR>
ROUTE	Set layer routing. ⓘ This command replaces all other routing commands.	COMMAND #ROUTE_layer_type,out_index,in_index<CR> FEEDBACK ~nn@ROUTE_layer_type,out_index<CR><LF>	layer_type Layer Enumeration 1 – Video 2 – Audio out_index 1 – OUT 1 HDMI 2 – OUT 2 HDBT 3 – OUT 3 HDBT 4 – OUT 4 HDBT 5 – OUT 5 HDBT 6 – OUT 6 HDBT 7 – OUT 7 HDBT 8 – OUT 8 HDBT 9 – OUT 9 HDBT * – ALL x – disconnect in_index – Source id 0 – Disconnect input port from output 1 – IN 1 HDMI 2 – IN 2 HDBT	Route video IN 2 HDBT to video OUT 8 HDBT: #ROUTE_1,8,2<CR>
ROUTE?	Get layer routing. ⓘ This command replaces all other routing commands.	COMMAND #ROUTE?_layer_type,out_index<CR> FEEDBACK ~nn@ROUTE_layer_type,out_index,in_index<CR><LF>	layer_type Layer Enumeration 1 – Video 2 – Audio out_index 1 – OUT 1 HDMI 2 – OUT 2 HDBT 3 – OUT 3 HDBT 4 – OUT 4 HDBT 5 – OUT 5 HDBT 6 – OUT 6 HDBT 7 – OUT 7 HDBT 8 – OUT 8 HDBT 9 – OUT 9 HDBT * – ALL x – disconnect in_index – Source id 0 – Disconnect input port from output 1 – IN 1 HDMI 2 – IN 2 HDBT	Get the layer routing: #ROUTE?_1,1,2<CR>
SIGNAL?	Get input signal status.	COMMAND #SIGNAL?_in_index<CR> FEEDBACK ~nn@SIGNAL_in_index,status<CR><LF>	in_index – Number that indicates the specific input: 1-16 status – Signal status according to signal validation: 0 – Off 1 – On	Get the input signal lock status of IN 1: #SIGNAL?_1<CR>
SN?	Get device serial number.	COMMAND #SN?_<CR> FEEDBACK ~nn@SN_serial_num<CR><LF>	serial_num – 14 decimal digits, factory assigned	Get the device serial number: #SN?_<CR>

Function	Description	Syntax	Parameters/Attributes	Example
TEST-MODE	<p>Perform device test according to defined test parameters.</p> <p>i This command starts device test procedure:</p> <p>When the command replies OK, MTX3-34-M enters "Keyboard Testing Mode":</p> <p>When a button on the front panel is pressed, the LCD display echoes "-01@EXT-KEYBUTTON xxx,DOWN".</p> <p>When the button is released, the LCD display echoes "-01@EXT-KEYBUTTON ALL,UP".</p> <p>When testing is complete, please power the matrix off and then on to return to normal operation.</p> <p>Note: Some functions are not supported in "TEST-MODE".</p>	COMMAND #TEST-MODE<CR> FEEDBACK ~nn@TEST-MODE_result<CR><LF>	result – Test Results 0 – OK 1 – Failed (general) 2...N – Device specific failed error code	Perform device test according to defined test parameters: #TEST-MODE<CR>
TIME	<p>Set device time and date.</p> <p>i The year must be 4 digits.</p> <p>The device does not validate the day of week from the date.</p> <p>Time format - 24 hours.</p> <p>Date format - Day, Month, Year.</p>	COMMAND #TIME_day_of_week,date,data<CR> FEEDBACK ~nn@TIME_day_of_week,date,data<CR><LF>	day_of_week – One of {SUN,MON,TUE,WED,THU,FRI,SAT} date – Format: DD-MM-YYYY. data – Format: hh:mm:ss where hh = hours mm = minutes ss = seconds	Set device time and date to December 5, 2018 at 2:30pm: #TIME_mon_05-12-2018,14:30:00<CR>
TIME?	<p>Get device time and date.</p> <p>i The year must be 4 digits.</p> <p>The device does not validate the day of week from the date.</p> <p>Time format - 24 hours.</p> <p>Date format - Day, Month, Year.</p>	COMMAND #TIME?_<CR> FEEDBACK ~nn@TIME_day_of_week,date,data<CR><LF>	day_of_week – One of {SUN,MON,TUE,WED,THU,FRI,SAT} date – Format: YYYY/MM/DD where YYYY = Year MM = Month DD = Day data – Format: hh:mm:ss where hh = hours mm = minutes ss = seconds	Get device time and date: #TIME?<CR>
TREBLE	<p>Set audio treble level.</p>	COMMAND #TREBLE_io_index,treble_level<CR> FEEDBACK ~nn@TREBLE_io_index,treble_level<CR><LF>	io_index – Number that indicates the specific input or output port: 1-16 treble_level – Audio parameter in the module card, range 0 – 15, ++, --.	Set audio treble level: #TREBLE_1,1<CR>
TREBLE?	<p>Get audio treble level.</p>	COMMAND #TREBLE?_io_index<CR> FEEDBACK ~nn@TREBLE_io_index,treble_level<CR><LF>	specific input or output port: 1-16 treble_level – Audio parameter in the module card, range 0 – 15, ++, --.	Get audio treble level: #TREBLE?_1<CR>
VERSION?	<p>Get firmware version number.</p>	COMMAND #VERSION?_<CR> FEEDBACK ~nn@VERSION_firmware_version<CR><LF>	firmware_version – XX.XX.XXXX where the digit groups are: major.minor.build version	Get the device firmware version number: #VERSION?_<CR>
VFRZ	<p>Set freeze on selected output.</p>	COMMAND #VFRZ_out_index,freeze_flag<CR> FEEDBACK ~nn@VFRZ_out_index,freeze_flag<CR><LF>	out_index – Number that indicates the specific output: 1-16 freeze_flag – On/Off 0 – Off 1 – On	Set freeze on selected output: #VFRZ_1,1<CR>
VFRZ?	<p>Get output freeze status.</p>	COMMAND #VFRZ?_out_index<CR> FEEDBACK ~nn@VFRZ_out_index,freeze_flag<CR><LF>	out_index – Number that indicates the specific output: 1-16 freeze_flag – On/Off 0 – Off 1 – On	Get output freeze status: #VFRZ?_1<CR>

Function	Description	Syntax	Parameters/Attributes	Example
VID	<p>LEGACY COMMAND. Set video switch state.</p> <p>① The GET command identifies input switching on Step-in clients.</p> <p>The SET command is for remote input switching on Step-in clients (essentially via by the Web).</p> <p>This is a legacy command. New Step-in modules support the ROUTE command.</p>	<p>COMMAND #VID_in_id>out_id<CR></p> <p>FEEDBACK ~nn@VID_in_id>out_id<CR><LF></p>	<p>in_id – Indicates the ID of the input: 1-16</p> <p>> – Connection character between in and out parameters</p> <p>out_id – Output number</p> <p>* for all outputs</p>	Switch IN 1 to OUT 3: #VID_1>3<CR>
VID-PATTERN	Set test pattern on output.	<p>COMMAND #VID-PATTERN_out_index,pattern_id<CR></p> <p>FEEDBACK ~nn@VID-PATTERN_out_index,pattern_id<CR><LF></p>	<p>out_index – Number that indicates the specific output: 1-16</p> <p>pattern_id – 1-127</p>	Switch PATTERN 1 to OUT 3: #VID-PATTERN_3,1<CR>
VID-PATTERN?	Get test pattern on output.	<p>COMMAND #VID-PATTERN?_out_index<CR></p> <p>FEEDBACK ~nn@VID-PATTERN_out_index,pattern_id<CR><LF></p>	<p>out_index – Number that indicates the specific output: 1-16</p> <p>pattern_id – 1-127</p>	Get test pattern on output: #VID-PATTERN?_3<CR>
VID-RES	<p>Set output resolution.</p> <p>① "Set" command with is_native=ON sets native resolution on selected output (resolution index sent = 0). Device sends as answer actual VIC ID of native resolution.</p> <p>To use "custom resolutions" (entries 100-105 In View Modes), define them using the DEF-RES command.</p>	<p>COMMAND #VID-RES_io_mode,io_index,is_native,resolution<CR></p> <p>FEEDBACK ~nn@VID-RES_io_mode,io_index,is_native,resolution<CR><LF></p>	<p>io_mode – Input/Output 0 – Input 1 – Output</p> <p>io_index – Number that indicates the specific input or output port: 1-N (N= the total number of input or output ports)</p> <p>is_native – Native resolution flag 0 – Off 1 – On</p> <p>resolution – Resolution index 0=No Signal (for input) / Native – EDID (for output) 1=640x480p@59.94Hz/60Hz 2=720x480p@59.94Hz/60Hz 4=1280x720p@59.94Hz/60Hz 5=1920x1080i@59.94Hz/60Hz 6=720(1440)x480i@59.94Hz/60Hz 8=720(1440)x240p@59.94Hz/60Hz 10=2880x480i@59.94Hz/60Hz 12=2880x240p@59.94Hz/60Hz 14=1440x480p@59.94Hz/60Hz 16=1920x1080p@59.94Hz/60Hz 17=720x576p@50Hz 19=1280x720p@50Hz 20=1920x1080i@50Hz 21=720(1440)x576i@50Hz 23=720(1440)x288p@50Hz 25=2880x576i@50Hz 27=2880x288p@50Hz 29=1440x576p@50Hz 31=1920x1080p@50Hz 32=1920x1080p@23.97Hz/24Hz 33=1920x1080p@25Hz 34=1920x1080p@29.97Hz/30Hz 35=2880x480p@59.94Hz/60Hz 37=2880x576p@50Hz 40=1920x1080i@100Hz 41=1280x720p@100Hz 42=720x576p@100Hz 44=720(1440)x576i@100Hz 46=1920x1080i@119.88/120Hz 47=1280x720p@119.88/120Hz 48=720x480p@119.88/120Hz 50=720(1440)x480i@119.88/120Hz 52=720x576p@200Hz 54=720(1440)x576i@200Hz 56=720x480p@239.76/240Hz 58=720(1440)x480i@239.76/240Hz</p>	Set output resolution: #VID-RES_1,1,1,1<CR>
VID-RES?	<p>Get output resolution.</p> <p>① "Get" command with is_native=ON returns native resolution VIC, with is_native=OFF returns current resolution.</p> <p>To use "custom resolutions" (entries 100-105 In View Modes), define them using the DEF-RES command.</p>	<p>COMMAND #VID-RES?_io_mode,io_index,is_native<CR></p> <p>FEEDBACK ~nn@VID-RES?_io_mode,io_index,is_native,resolution<CR><LF></p>	<p>io_mode – Input/Output 0 – Input 1 – Output</p> <p>io_index – Number that indicates the specific input or output port: 1-16</p> <p>is_native – Native resolution flag 0 – Off</p> <p>resolution – Resolution index, see VID-RES command for list.</p>	Set output resolution: #VID-RES?_1,1,1,1<CR>

Function	Description	Syntax	Parameters/Attributes	Example
X-MUTE	<p>Set mute ON/OFF on a specific signal.</p> <p>i This command is designed to Mute a Signal. This means that it could be applicable to both audio and video.</p> <p>This is an Extended Protocol 3000 command.</p>	<p>COMMAND</p> <pre>#X-MUTE_<direction_type>.<port_format>.<port_index>.<signal_type>.<index>,state<CR></pre> <p>FEEDBACK</p> <pre>~nn@X-MUTE_<direction_type>.<port_format>.<port_index>.<signal_type>.<index>,state<CR><LF></pre>	<p>The following attributes comprise the signal ID:</p> <ul style="list-style-type: none"> ▪ <direction_type> – Direction of the port: <ul style="list-style-type: none"> ○ IN – Input ▪ <port_format> – Type of signal on the port: <ul style="list-style-type: none"> ○ ANALOG_AUDIO ▪ <port_index> – The port number as printed on the front or rear panel ▪ <signal_type> – Signal ID attribute: <ul style="list-style-type: none"> ○ AUDIO ▪ <index> – Indicates a specific channel number when there are multiple channels of the same type <p>state – OFF/ON (not case sensitive)</p>	<p>Mute the video on HDMI OUT 4:</p> <pre>#X-MUTE_out.AUDIO.1</pre>
X-MUTE?	<p>Get mute ON/OFF state on a specific signal.</p> <p>i This command is designed to Mute a Signal. This means that it could be applicable on any type of signal. Could be audio, video and maybe IR, USB or data if this capability is supported by the product.</p> <p>This is an Extended Protocol 3000 command.</p>	<p>COMMAND</p> <pre>#X-MUTE?_<direction_type>.<port_format>.<port_index>.<signal_type>.<index><CR></pre> <p>FEEDBACK</p> <pre>~nn@X-MUTE_<direction_type>.<port_format>.<port_index>.<signal_type>.<index>,state<CR><LF></pre>	<p>The following attributes comprise the signal ID:</p> <ul style="list-style-type: none"> ▪ <direction_type> – Direction of the port: <ul style="list-style-type: none"> ○ IN – Input ▪ <port_format> – Type of signal on the port: <ul style="list-style-type: none"> ○ ANALOG_AUDIO ▪ <port_index> – The port number as printed on the front or rear panel ▪ <signal_type> – Signal ID attribute: <ul style="list-style-type: none"> ○ AUDIO ▪ <index> – Indicates a specific channel number when there are multiple channels of the same type <p>state – OFF/ON (not case sensitive)</p>	<p>Get the mute ON/OFF state on a specific signal:</p> <pre>#X-MUTE?_out.AUDIO.4.video.1<CR></pre>

Result and Error Codes

Syntax

In case of an error, the device responds with an error message. The error message syntax:

- **~NN@ERR XXX<CR><LF>** – when general error, no specific command
- **~NN@CMD ERR XXX<CR><LF>** – for specific command
- **NN** – machine number of device, default = 01
- **XXX** – error code

Error Codes

Error Name	Error Code	Description
P3K_NO_ERROR	0	No error
ERR_PROTOCOL_SYNTAX	1	Protocol syntax
ERR_COMMAND_NOT_AVAILABLE	2	Command not available
ERR_PARAMETER_OUT_OF_RANGE	3	Parameter out of range
ERR_UNAUTHORIZED_ACCESS	4	Unauthorized access
ERR_INTERNAL_FW_ERROR	5	Internal FW error
ERR_BUSY	6	Protocol busy
ERR_WRONG_CRC	7	Wrong CRC
ERR_TIMEDOUT	8	Timeout
ERR_RESERVED	9	(Reserved)
ERR_FW_NOT_ENOUGH_SPACE	10	Not enough space for data (firmware, FPGA...)
ERR_FS_NOT_ENOUGH_SPACE	11	Not enough space – file system
ERR_FS_FILE_NOT_EXISTS	12	File does not exist
ERR_FS_FILE_CANT_CREATED	13	File can't be created
ERR_FS_FILE_CANT_OPEN	14	File can't open
ERR_FEATURE_NOT_SUPPORTED	15	Feature is not supported
ERR_RESERVED_2	16	(Reserved)
ERR_RESERVED_3	17	(Reserved)
ERR_RESERVED_4	18	(Reserved)
ERR_RESERVED_5	19	(Reserved)
ERR_RESERVED_6	20	(Reserved)
ERR_PACKET_CRC	21	Packet CRC error
ERR_PACKET_MISSED	22	Packet number isn't expected (missing packet)
ERR_PACKET_SIZE	23	Packet size is wrong
ERR_RESERVED_7	24	(Reserved)
ERR_RESERVED_8	25	(Reserved)
ERR_RESERVED_9	26	(Reserved)
ERR_RESERVED_10	27	(Reserved)
ERR_RESERVED_11	28	(Reserved)
ERR_RESERVED_12	29	(Reserved)
ERR_EDID_CORRUPTED	30	EDID corrupted
ERR_NON_LISTED	31	Device specific errors
ERR_SAME_CRC	32	File has the same CRC – not changed
ERR_WRONG_MODE	33	Wrong operation mode
ERR_NOT_CONFIGURED	34	Device/chip was not initialized

The warranty obligations of Kramer Electronics Inc. ("Kramer Electronics") for this product are limited to the terms set forth below:

What is Covered

This limited warranty covers defects in materials and workmanship in this product.

What is Not Covered

This limited warranty does not cover any damage, deterioration or malfunction resulting from any alteration, modification, improper or unreasonable use or maintenance, misuse, abuse, accident, neglect, exposure to excess moisture, fire, improper packing and shipping (such claims must be presented to the carrier), lightning, power surges, or other acts of nature. This limited warranty does not cover any damage, deterioration or malfunction resulting from the installation or removal of this product from any installation, any unauthorized tampering with this product, any repairs attempted by anyone unauthorized by Kramer Electronics to make such repairs, or any other cause which does not relate directly to a defect in materials and/or workmanship of this product. This limited warranty does not cover cartons, equipment enclosures, cables or accessories used in conjunction with this product.

Without limiting any other exclusion herein, Kramer Electronics does not warrant that the product covered hereby, including, without limitation, the technology and/or integrated circuit(s) included in the product, will not become obsolete or that such items are or will remain compatible with any other product or technology with which the product may be used.

How Long this Coverage Lasts

The standard limited warranty for Kramer products is seven (7) years from the date of original purchase, with the following exceptions:

1. All Kramer VIA hardware products are covered by a standard three (3) year warranty for the VIA hardware and a standard three (3) year warranty for firmware and software updates; all Kramer VIA accessories, adapters, tags, and dongles are covered by a standard one (1) year warranty.
2. Kramer fiber optic cables, adapter-size fiber optic extenders, pluggable optical modules, active cables, cable retractors, ring mounted adapters, portable power chargers, Kramer speakers, and Kramer touch panels are covered by a standard one (1) year warranty. Kramer 7-inch touch panels purchased on or after April 1st, 2020 are covered by a standard two (2) year warranty.
3. All Kramer Calibre products, all Kramer Minicom digital signage products, all HighSecLabs products, all streaming, and all wireless products are covered by a standard three (3) year warranty.
4. All Sierra Video MultiViewers are covered by a standard five (5) year warranty.
5. Sierra switchers & control panels are covered by a standard seven (7) year warranty (excluding power supplies and fans that are covered for three (3) years).
6. K-Touch software is covered by a standard one (1) year warranty for software updates.
7. All Kramer passive cables are covered by a lifetime warranty.

Who is Covered

Only the original purchaser of this product is covered under this limited warranty. This limited warranty is not transferable to subsequent purchasers or owners of this product.

What Kramer Electronics Will Do

Kramer Electronics will, at its sole option, provide one of the following three remedies to whatever extent it shall deem necessary to satisfy a proper claim under this limited warranty:

1. Elect to repair or facilitate the repair of any defective parts within a reasonable period of time, free of any charge for the necessary parts and labor to complete the repair and restore this product to its proper operating condition. Kramer Electronics will also pay the shipping costs necessary to return this product once the repair is complete.
2. Replace this product with a direct replacement or with a similar product deemed by Kramer Electronics to perform substantially the same function as the original product. If a direct or similar replacement product is supplied, the original product's end warranty date remains unchanged and is transferred to the replacement product.
3. Issue a refund of the original purchase price less depreciation to be determined based on the age of the product at the time remedy is sought under this limited warranty.

What Kramer Electronics Will Not Do Under This Limited Warranty

If this product is returned to Kramer Electronics or the authorized dealer from which it was purchased or any other party authorized to repair Kramer Electronics products, this product must be insured during shipment, with the insurance and shipping charges prepaid by you. If this product is returned uninsured, you assume all risks of loss or damage during shipment. Kramer Electronics will not be responsible for any costs related to the removal or re-installation of this product from or into any installation. Kramer Electronics will not be responsible for any costs related to any setting up this product, any adjustment of user controls or any programming required for a specific installation of this product.

How to Obtain a Remedy Under This Limited Warranty

To obtain a remedy under this limited warranty, you must contact either the authorized Kramer Electronics reseller from whom you purchased this product or the Kramer Electronics office nearest you. For a list of authorized Kramer Electronics resellers and/or Kramer Electronics authorized service providers, visit our web site at www.kramerav.com or contact the Kramer Electronics office nearest you.

In order to pursue any remedy under this limited warranty, you must possess an original, dated receipt as proof of purchase from an authorized Kramer Electronics reseller. If this product is returned under this limited warranty, a return authorization number, obtained from Kramer Electronics, will be required (RMA number). You may also be directed to an authorized reseller or a person authorized by Kramer Electronics to repair the product.

If it is decided that this product should be returned directly to Kramer Electronics, this product should be properly packed, preferably in the original carton, for shipping. Cartons not bearing a return authorization number will be refused.

Limitation of Liability

THE MAXIMUM LIABILITY OF KRAMER ELECTRONICS UNDER THIS LIMITED WARRANTY SHALL NOT EXCEED THE ACTUAL PURCHASE PRICE PAID FOR THE PRODUCT. TO THE MAXIMUM EXTENT PERMITTED BY LAW, KRAMER ELECTRONICS IS NOT RESPONSIBLE FOR DIRECT, SPECIAL, INCIDENTAL OR CONSEQUENTIAL DAMAGES RESULTING FROM ANY BREACH OF WARRANTY OR CONDITION, OR UNDER ANY OTHER LEGAL THEORY. Some countries, districts or states do not allow the exclusion or limitation of relief, special, incidental, consequential or indirect damages, or the limitation of liability to specified amounts, so the above limitations or exclusions may not apply to you.

Exclusive Remedy

TO THE MAXIMUM EXTENT PERMITTED BY LAW, THIS LIMITED WARRANTY AND THE REMEDIES SET FORTH ABOVE ARE EXCLUSIVE AND IN LIEU OF ALL OTHER WARRANTIES, REMEDIES AND CONDITIONS, WHETHER ORAL OR WRITTEN, EXPRESS OR IMPLIED. TO THE MAXIMUM EXTENT PERMITTED BY LAW, KRAMER ELECTRONICS SPECIFICALLY DISCLAIMS ANY AND ALL IMPLIED WARRANTIES, INCLUDING, WITHOUT LIMITATION, WARRANTIES OF MERCHANTABILITY AND FITNESS FOR A PARTICULAR PURPOSE. IF KRAMER ELECTRONICS CANNOT LAWFULLY DISCLAIM OR EXCLUDE IMPLIED WARRANTIES UNDER APPLICABLE LAW, THEN ALL IMPLIED WARRANTIES COVERING THIS PRODUCT, INCLUDING WARRANTIES OF MERCHANTABILITY AND FITNESS FOR A PARTICULAR PURPOSE, SHALL APPLY TO THIS PRODUCT AS PROVIDED UNDER APPLICABLE LAW. IF ANY PRODUCT TO WHICH THIS LIMITED WARRANTY APPLIES IS A "CONSUMER PRODUCT" UNDER THE MAGNUSON-MOSS WARRANTY ACT (15 U.S.C.A. §2301, ET SEQ.) OR OTHER APPLICABLE LAW, THE FOREGOING DISCLAIMER OF IMPLIED WARRANTIES SHALL NOT APPLY TO YOU, AND ALL IMPLIED WARRANTIES ON THIS PRODUCT, INCLUDING WARRANTIES OF MERCHANTABILITY AND FITNESS FOR THE PARTICULAR PURPOSE, SHALL APPLY AS PROVIDED UNDER APPLICABLE LAW.

Other Conditions

This limited warranty gives you specific legal rights, and you may have other rights which vary from country to country or state to state.

This limited warranty is void if (i) the label bearing the serial number of this product has been removed or defaced, (ii) the product is not distributed by Kramer Electronics or (iii) this product is not purchased from an authorized Kramer Electronics reseller. If you are unsure whether a reseller is an authorized Kramer Electronics reseller, visit our web site at www.kramerav.com or contact a Kramer Electronics office from the list at the end of this document.

Your rights under this limited warranty are not diminished if you do not complete and return the product registration form or complete and submit the online product registration form. Kramer Electronics thanks you for purchasing a Kramer Electronics product. We hope it will give you years of satisfaction.



HDMI™
HIGH-DEFINITION MULTIMEDIA INTERFACE



P/N: 2900-301590

Rev: 5



SAFETY WARNING

Disconnect the unit from the power supply before opening and servicing

For the latest information on our products and a list of Kramer distributors, visit our website where updates to this user manual may be found.

We welcome your questions, comments, and feedback.

The terms HDMI, HDMI High-Definition Multimedia Interface, and the HDMI Logo are trademarks or registered trademarks of HDMI Licensing Administrator, Inc. All brand names, product names, and trademarks are the property of their respective owners.